

Rear Compartment Lid Release Actuator

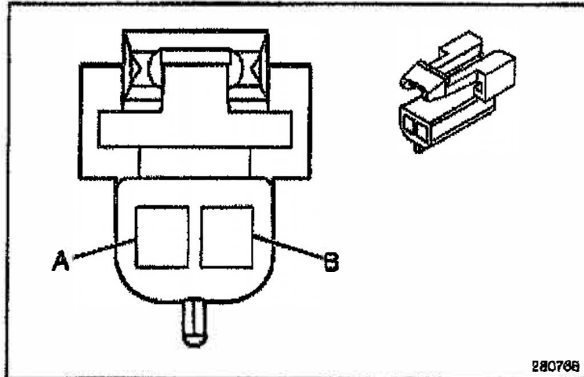

Connector Part Information		<ul style="list-style-type: none"> • 12052832 • 2-Way F Metri-Pack 150 Series (BLK) 	
Pin	Wire Color	Circuit No.	Function
A	BLK/WHT	58	Trunk Release Motor Control
B	BLK	350	Ground

Rear Compartment Lid Release Actuator