



'08

MAZDA **CX-9**

Quick Tips®

Reference

Guide for

Controls and

Functions



mazda®

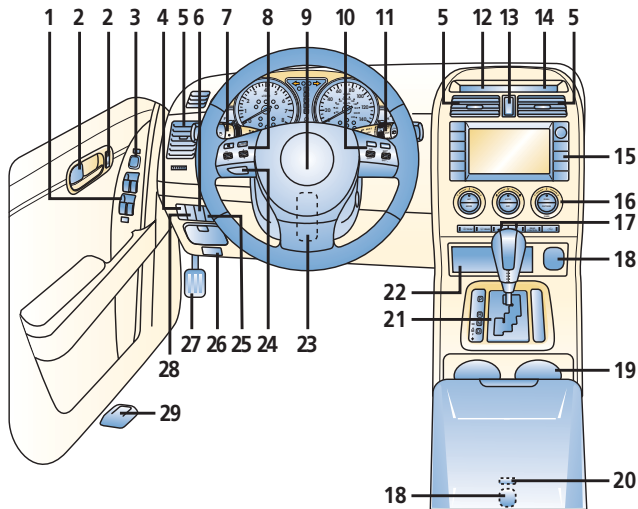

Getting Started

MAZDA CX-9 Quick Tips® are designed to quickly familiarize you with some important features of your MAZDA CX-9.

This Driver's View tab is your index to the Quick Tips®, locate the item you would like to learn more about and then turn to the listed tab.

Be sure to see the tab called Getting Started, this section contains important operating tips about your MAZDA CX-9.

Items identified in blue text call out unique features.

1. **Power window switches**, see Mirrors/Windows
2. **Door locks**, see Locks
3. **Mirror controls**, see Mirrors/Windows
4. **HID headlights leveling switch***
Set position at 0 unless vehicle is loaded heavily, leveling switch adjusts headlight angle to compensate for weight of passengers and cargo, see Owner's Manual.
5. **Air vents**
6. **TCS OFF switch**, see Instrument Cluster
7. **Turn signal/lighting control lever**, see Getting Started
8. **Audio control switches**, see Audio Systems
9. **Horn/Air bag**
10. **Cruise control**, see Getting Started
11. **Wiper/washer control lever**, see Getting Started
12. **Information display**, see Audio Systems
13. **▲ Hazard warning switch**
Push to activate/deactivate.
14. **Passenger air bag off indicator**, see Getting Started
15. **NAVI display***, see Owner's Manual
16. **Climate control panel**, see Climate Controls
17. **Seat warmer***, Press: On/off.
18. **Accessory socket**
19. **Cup holders**
To access cup holders: Press cover down and lift.
20. **Auxiliary jack**
Connect portable music device to in-vehicle audio system.
21. **Gearshift lever**, see Transaxle
22. **Storage**
23. **Tilt/telescopic steering-wheel release lever**, Pull lever down to unlock column; adjust tilt angle/column length; pull up to lock column.
⚠ WARNING: Do not adjust steering-wheel while driving because you may lose control of the vehicle.
24. **HF/TEL Hands-Free Telephone button***, see Getting Started
25. **Power liftgate switch***
Press for one second or more to fully open/close liftgate.
26. **🚗 Hood release handle**
Pull release handle to unlock.
27. **Parking-brake**
To engage: Push down; to release: Push down slightly, then release.
28. **BSM OFF switch***, see Getting Started
29. **🚰 Fuel-filler lid release**
To open: Pull lever upward and release.

*Denotes optional equipment

Always check the Owner's Manual for more operating information and safety features

GETTING STARTED

Blind Spot Monitoring (BSM)*

BSM system will assist driver by monitoring detection areas on either side of vehicle to the rear.

System is only active above 20-mph.

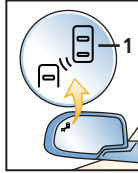
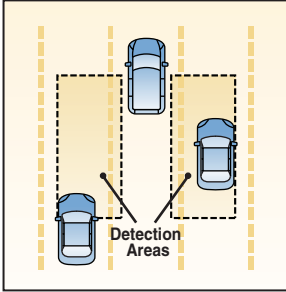

BSM warning light (1) will appear in either outside side-mirror when a vehicle is detected in the detection area.

Tip: Audible warning beep is heard when turn signal is activated and a vehicle is detected in the detection area.

WARNINGS: Do not rely completely on BSM system; make sure to look over your shoulder before making any lane change.

BSM system may not function normally when towing a trailer, system should be deactivated.

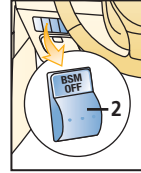

Deactivating BSM system: Press BSM OFF switch (2). BSM OFF indicator will illuminate in instrument cluster.

Press BSM OFF switch again to reactivate system.

Indicator light flashes if system has a malfunction, dealer inspection required.

See Owner's Manual and BSM Quick Start Guide for complete operating instructions and warnings.

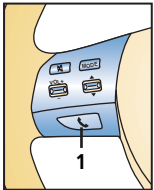
**Bluetooth Hands-Free Telephone (HF/TEL)***

System consists of Hands-Free Telephone (HF/TEL) button (1) located on steering-wheel, information display, microphone and audio/navigation system*; system only functions with a Bluetooth type mobile telephone, a mobile telephone can be programmed only when vehicle is parked.

Hands-Free Telephone setup
Pair a phone

1. Press telephone button (1); say "setup."
2. System prompts you with available options; say "pairing options."

3. After prompts, say "pair a phone."
4. System will request a 4-digit PIN of your choice (record PIN number for future phone pairing procedure), slowly say your 4-digit PIN and confirm.
5. After prompt, follow phone manufacturer's instructions to search for Bluetooth device.
6. Once device is found, select "Mazda," enter your selected 4-digit PIN on phone's numeric keypad when requested.
7. System prompts you to name the phone.
8. System will ask for a phone priority number between 1-7, 1 being highest.
9. When programming is complete, system will indicate "pairing complete."

Language

Press telephone button (1); say "setup" after beep, say "language" after beep, say "English," "French" or "Spanish," you will be asked "is this correct," say "yes" after the beep, then follow any additional prompts.

Dialing a phone number

Press telephone button (1); say "dial" after beep, slowly say phone number after the prompt, system verifies number is correct; then connects your call.

Redialing last-called number

Press telephone button (1); say "redial" after beep, system will redial last dialed phone number.

See Owner's Manual for complete operating instructions and warnings.

*Denotes optional equipment

Always check the Owner's Manual for more operating information and safety features

GETTING STARTED

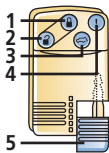

Advanced keyless entry/start system*

Advanced key must be carried by driver to operate properly.

Refer to Owner's Manual for additional instructions.

Tip: Do not use advanced key with activated cell phone in the same pocket, advanced key functions may become disabled.

Advanced keyless system customization

Your authorized Mazda Dealer can customize your system if desired with features such as auto-lock, which can be programmed to automatically lock vehicle after driving and exiting vehicle.

For additional information, see Owner's Manual.

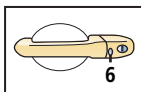

Locking doors

Driver's/passenger's door request switch: Press (6) once on either door to lock other doors. Press and hold driver's door request switch (6) to close windows and moonroof, release to stop.

Advanced key transmitter: Press button (1); pressing again within a few seconds causes doors to unlock and horn to beep.

Unlocking doors/opening liftgate

Driver's door request switch: Press (6) to unlock driver's door; press again within 3 seconds to unlock other doors and liftgate.



Passenger's door request switch: Press (6) on passenger's door; all doors and liftgate unlock simultaneously.

Liftgate request switch: Press (7) on liftgate, doors and liftgate will lock/unlock.

Advanced key transmitter: Press button (2) for driver's door; press again within 1 1/2 seconds to unlock other doors and liftgate, hold to lower front windows and open moonroof, release to stop; with all doors unlocked, press and hold button (3) for one second or more to open/close liftgate.

Activating panic alarm

Panic alarm: Press and hold button (4) for more than 1 second; horn sounds, hazard warning lights flash; to stop, pressing any remote button.

*Denotes optional equipment

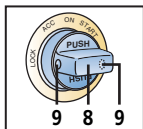

Starting engine

Press start knob (8); when KEY indicator (green) illuminates on instrument

cluster; turn start knob (8) to START position to start engine.

Auxiliary key operation

If advanced key cannot be used due to a malfunction or dead advanced key battery, use auxiliary key (5) to lock/unlock doors and to start vehicle.

To start vehicle: Remove start knob cover (8) by pressing both side release buttons (9) while pulling; insert auxiliary key into key cylinder and turn to start engine.

Tip: Do not place advanced key on or around dashboard, storage compartments such as glove box or in open liftgate/cargo

area, engine may not start or warnings may activate.

Turning off engine

Turn start knob to ACC position to turn engine off, push in and turn start knob to LOCK position.

Tip: Vehicle battery may be discharged and vehicle security compromised if start knob is left in ACC position.

Always put vehicle in Park (P), set parking brake and turn start knob to LOCK position when exiting vehicle.

System operation warnings

KEY indicator light flashes (green) indicates advanced key transmitter battery power is low.

KEY indicator light illuminated continuously (red) indicates system malfunction, and auxiliary key should be used, have vehicle inspected at an Authorized Mazda Dealer as soon as possible.

Tip: When using advanced keyless system, unless reprogrammed by dealer, system will beep as confirmation of lock/unlock requests, system will also beep if start knob is left in ACC position, advanced key has been left in vehicle or if advanced key is removed from vehicle while vehicle is running.

For additional system operation warnings, see Owner's Manual.

Replacing battery

See Owner's Manual

Cautions on use

To avoid damage to advanced key, do not allow any severe impacts or contact with liquids, do not place heavy objects on advanced key and do not leave advanced key exposed to direct sunlight or high temperatures, see Owner's Manual for all cautions and warnings.

Always check the Owner's Manual for more operating information and safety features

GETTING STARTED

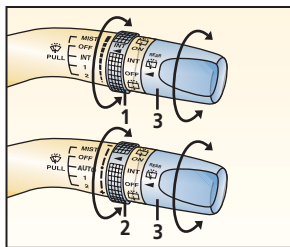

Wiper/washer lever

Single wipe: Push lever up.

Washer: Pull back, also operates wipers.

Intermittent wiper: One click down, to change interval speed rotate ring (1).

Auto*: One click down, rain sensor senses rain amount on windshield, then controls wiper automatically. Rain sensor sensitivity is adjusted from high sensitivity (+) to less sensitivity (-) by rotating ring (2).

Normal wiper speed: Two clicks down.

High-speed wiper: Three clicks down.

Rear window wiper/washer

To activate rear interval wiper: Rotate knob (3) up to INT.

To activate rear normal speed wiper: Rotate knob (3) up to ON.

To activate rear washer: Rotate knob (3) to and release.

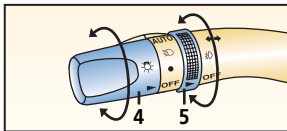

Turn signal/lighting lever

OFF = Lights off

○ = Tail, parking and dashboard lights on: Rotate knob (4) to first notch

= Tail, parking, dashboard and headlights on: Rotate knob (4) to second notch

High beams on/off: Push forward/pull back to detent.

To flash high beams: Pull back slightly and release.

AUTO* = With ignition switch in ON position; headlights and exterior lights automatically turn ON/OFF depending on surrounding darkness/lightness; rotate knob (4) to third notch = Fog lights* on: Rotate (5); functions only with low beams on. Turn signals right/left: move lever up/down.

Tip: With **AUTO* ON/OFF** or **auto OFF** system, headlights switch off automatically within 30 seconds if lights are left on or with **AUTO** selected, switch in lock position or key removed.

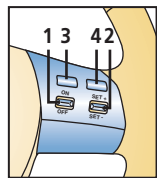

Cruise control

Operates above 19 mph. Push up/press down ON/OFF switch (1) to enable/disable.

To set speed: Press switch (2) down and release.

To increase set speed: Push switch (2) up and release at desired speed.

To decrease set speed: Press switch (2) down and release at desired speed.

To cancel: Press down ON/Off switch (1), tap brake or press CANCEL switch (3).

To resume cruising speed: Press switch (4); resume function will not operate if cruise control was cancelled using ON/OFF switch.

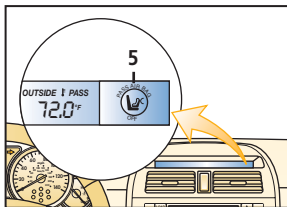

Passenger air bag deactivation indicator light

Front air bag deactivation indicator light (5) provides current status of front passenger air bag and pretensioner system.

If total seated weight on front passenger seat is less than approximately 66 lb., front passenger air bag deactivation indicator light illuminates, front passenger and side air

bags/pretensioner will not deploy/activate in an accident.

If the total seated weight is greater than approximately 93 lb., light does not illuminate, and the front passenger and side air bags/pretensioner will deploy/activate in an appropriate accident.

See Owner's Manual for additional information on this feature and the air bag system.

WARNINGS: Even with a deactivation system, never place rear-facing infant-safety seat in front of any air bag, an infant is in serious danger of being injured or killed.

If you must install a forward-facing child-safety seat in the front seating position, move vehicle seat as far back as possible.

*Denotes optional equipment

Always check the Owner's Manual for more operating information and safety features

INSTRUMENT CLUSTER

GAUGES

1. Instrument cluster dimmer select knob

With headlights ON: Rotate knob to increase/decrease brightness. Headlights/parking lights ON, ignition key ON: Illumination changes brightness when knob is pressed.

2. Tachometer

3. Gear position indicator

Displays current gear position or manual mode.

4. Gear indicator

Displays current gear when in D or M.

5. Speedometer

6. Odometer/Trip meter selector

Press to view odometer, trip meter A and B; press and hold to reset trip meter A/B settings.

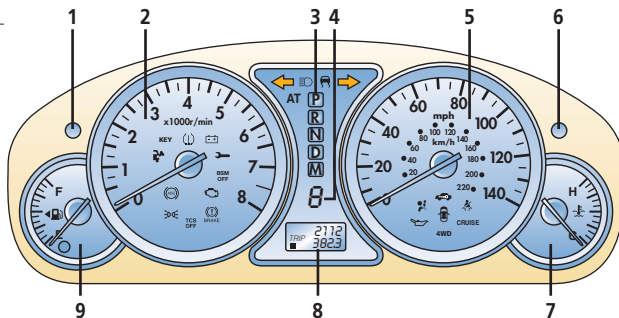

7. Engine coolant temperature gauge

Stop car if above normal range, turn off engine, let vehicle cool; check coolant level when safe.

8. Odometer/Trip meter

20.1-gallon/76-liter tank

*Denotes optional equipment

WARNING LIGHTS

• CRUISE Cruise control on

Amber light: Cruise control system activated; Green light: Cruising speed set; see Getting Started

• Tire Pressure Monitoring System (TPMS)*, see Driving Tips

• High beams on

• Engine oil-pressure

Stop car when safe and turn off engine; check oil level

• Brake system

Parking brake on/low brake fluid

• Always fasten seat belts

• Security indicator light*

• **KEY***, see Getting Started

• Low fuel

• BSM OFF*

BSM system is deactivated, see Getting Started

• Check engine

Dealer inspection required if light remains on, see Owner's Manual

• Charging system

Charging system malfunction; dealer inspection required

• Air bag/front seat belt pretensioner system

If light flashes or stays on, the air bags/front seat belt pretensioners may not operate in an accident; dealer inspection required

• AT Automatic transaxle*

Automatic transaxle malfunction; dealer inspection required

• Anti-lock Brake System (ABS)

ABS malfunction, normal brakes only; dealer inspection required

• Check fuel cap

Fuel cap not securely tightened

• Door ajar

• TCS OFF

Traction Control System is deactivated

• Lights ON indicator light*

• Traction Control System (TCS)/Dynamic Stability Control (DSC)/Roll Stability Control (RSC)

Light flashes when system is activated while driving; dealer inspection required if light remains on

• 4WD AWD warning light*

Flashing lamp indicates high temperature differential oil, illuminated lamp indicates an abnormality with AWD system; dealer inspection required

• Powertrain malfunction/reduced power

Dealer inspection required if light remains on, see Owner's Manual

Always check the Owner's Manual for more operating information and safety features

LOCKS

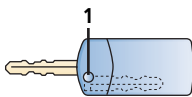

Key

Operates ignition and all locks.

Tips: Use key number plate to purchase a new key; store in safe place separate from vehicle.

Only advanced keyless system* automatically locks doors when leaving with key (dealer programmable feature).

Retractable type key

To fold/unfold press button (1).

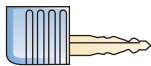

Auxiliary key*

See Getting Started

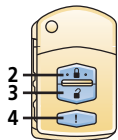

Keyless entry system

Functions only with ignition in OFF position.

To lock doors:

Press button (2);

pressing again within a few seconds causes doors to relock and horn to beep.

To unlock: Press button (3) for driver's door; press again within 3 seconds to unlock other doors and liftgate, press and hold to lower driver's and passenger windows and open moonroof, release to stop.

Panic alarm: Press and hold button (4) for more than 1 second; horn sounds, hazard warning lights flash; to stop, press any remote button.

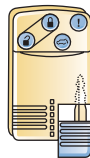

Advanced keyless entry/start system/auxiliary key*

See Getting Started

Illuminated entry system

Activates interior lights when dome light switch set to DOOR position; lights off after driver's door is locked or ignition in ON position.

Immobilizer system

Prevents engine from running unless coded key is used, see Owner's Manual.

WARNING: Never leave a child alone in vehicle and never leave any key where a child can find it, particularly advanced keys which give easier access to a curious child.

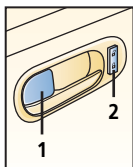

Manual door locks

To lock: Press front of button (1) toward door handle.
To unlock: Pull front of button away from door handle.

Power door locks

To lock/unlock all doors and liftgate from inside vehicle: Press bottom/top of switch (2).

Using mechanical key to unlock driver's front door: Rotate key to counterclockwise position for more than one second to unlock other doors and liftgate, continue to hold key in unlock position to roll front windows down and open moonroof. Using key to lock all doors: Rotate key to clockwise position, continue to hold key in lock position to roll front windows up and close moonroof, release to stop.

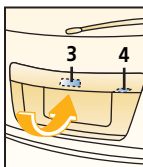

Liftgate

To open: Pull up on handle (3) and raise; to close: Push liftgate down with both hands until in near-shut position, easy closure system will close liftgate completely.

Liftgate request switch

Liftgate request switch* (4) operation, see Getting Started.

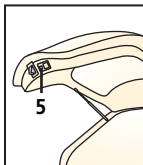

Power liftgate close switch

Press (5) for one second or more; hazard warning lights flash twice;

liftgate closes automatically after beep sound is heard.

WARNING: Always make sure hatch opening is clear before opening/closing. Never place hands or fingers around liftgate because liftgate closes automatically from near-shut position, this could cause hands and fingers to be pinched and injured.

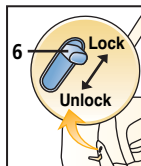

Child-safety locks

Located at edge of rear doors. To activate: Pull tab (6) up; door opens from outside only.

To cancel: Push tab (6) down.

WARNING: Since children may access either rear door, child-safety locks for both rear doors should be activated.

*Denotes optional equipment

Always check the Owner's Manual for more operating information and safety features

M I R R O R S / W I N D O W S

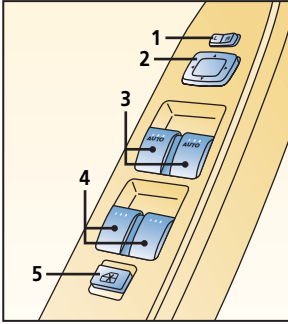

Dual power mirrors

Ignition switch must be in ACC or ON position.

To adjust left/right mirror: Press selector (1) left/right, press (2) in direction of desired movement.

Tip: To lock mirrors in place, move switch (1) to center position.

Power window switches

With ignition ON.

All windows controlled from driver's armrest; passenger doors have separate switches.

Front window switches

One-touch down/up: Press/pull AUTO switch (3) firmly and release, window goes down/up all the way, press/pull briefly to stop, press/pull lightly and hold for normal operation, momentarily press front power window switches, front windows will open to vent position.

Tip: During closing front window operation, front window will stop and open partway if object blocks window operation.

Rear window control switches

Push/pull (4) to open/close.

Power window lockout switch

Press button (5), only driver's window operates; press again for normal operation.

Power window initialization procedure

If battery is disconnected or power window fuse is replaced, the auto open/close and anti-pinch features will not function until initialization is complete.

Initialization procedure:

1. Turn ignition switch to "ON" position.
2. Make sure power window lockout switch on driver's door is not depressed.
3. Press power window switch down and fully open window.
4. Pull switch up and fully close window, continue holding switch up for about 2 seconds after window is fully closed.
5. Repeat Steps 3 and 4 for each front window.
6. Confirm power window switch operation.

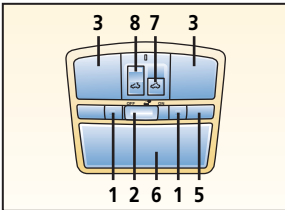

1. Map/reading light switch

Press on/off.

2. Interior light switch

OFF = Light always off
DOOR = Light on when door open
ON = Light always on

Tip: All interior lights can be turned ON/OFF using driver's overhead switch when all light switches are in DOOR position.

3. Front interior light

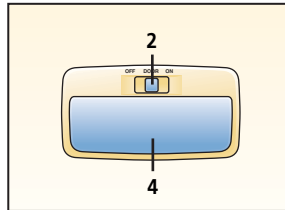

4. Rear interior light

5. Hands-Free Telephone/navigation microphone*

6. Storage/sunglasses holder

7. Moonroof tilt switch*

One-touch operation:

Tilt open/close, push/pull down switch.

8. Moonroof slide switch*

One-touch operation:
Slide open/close, press rear/front of switch.

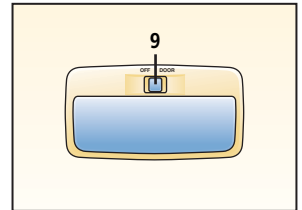

Tip: With all doors closed, moonroof and front windows can be opened via Keyless entry by pressing and holding unlock button, or opened/closed by turning and holding driver's door key toward front/rear of vehicle.

9. Cargo light

DOOR = Light on with liftgate open
OFF = Light always off

*Denotes optional equipment

Always check the Owner's Manual for more operating information and safety features

SEATS

Manual seat**1. Fore-aft adjustment**

Lift lever and hold, slide seat, release lever.

2. Raise/lower seat (Driver's seat only)

Pull/push lever and release.

3. Seat back angle

To adjust: Lift and hold lever, lean forward or backward to tilt seat, release lever.

4. Manual lumbar adjustment (Driver's seat only)

Pull lever forward repeatedly for more support.

5. Head restraint

To raise/lower: Pull up/hold release button (11) and push down.

Power seat***6. Seatback angle**

Press front/rear of switch.

7. Power lumbar adjustment*

Press front/rear of switch to increase/decrease lumbar support.

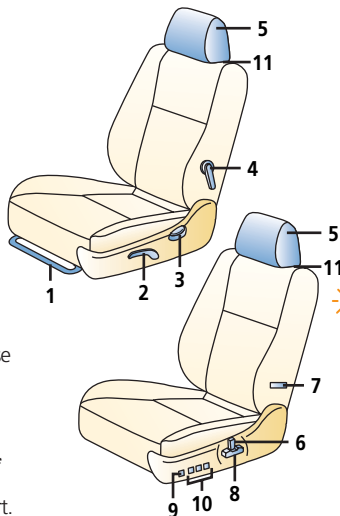
**8. Raise/lower front of seat**

Pull/push front of switch vertically.

Fore/aft adjustment

Slide switch horizontally.

Raise/lower rear of seat

Pull/push rear of switch vertically.

Raise/lower seat

Pull/push center of switch vertically.

Seat position memory*

Adjust seat, then press and hold set button (9), then select and press a memory position button (10) to save setting.

 **Tip: To program memory seat into advanced key*/retractable key, with ignition off; key removed and driver's door open, press and hold set button (9) while holding unlock button on transmitter until beep is heard.**

 **WARNINGS: Do not adjust seats while driving.**

Seat belts must always be worn when vehicle is in motion.

Air bags are supplemental and do not replace seat belt usage.

Always wear your seat belt and properly secure children 12 and under in the rear seat.

Even with a deactivation system, never place rear-facing infant-safety seat in front of any air bag, an infant is in serious danger of being injured or killed.

If you must install a forward-facing child-safety seat in the front seating position, move vehicle seat as far back as possible.

Shoulder belt height adjustment

To raise: Push adjuster up.

To lower: Pull button (1), slide down; release button.

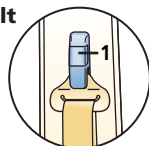

 **WARNING: Make sure adjuster locks in one of its positions.**

Child-safety seat

To install in rear outboard seats: Use dual locking mode retractor seat belts; see Owner's Manual for proper installation and child seat tether and LATCH system instructions.

 **WARNING: Use age appropriate child restraints, see Owner's Manual and state or province laws.**

Seat belt emergency locking mode

Belts lock only on hard acceleration, braking, cornering or impacts of about 5 mph or more.

Automatic locking mode (all seat belts except Driver's seat belt)

Must be used when installing child-safety seat.

To activate: Pull webbing fully out of retractor, allow belt to retract until click is heard; belt will only tighten.

To disengage: Unbuckle belt and allow webbing to retract fully.

*Denotes optional equipment

Always check the Owner's Manual for more operating information and safety features

REAR SEATS

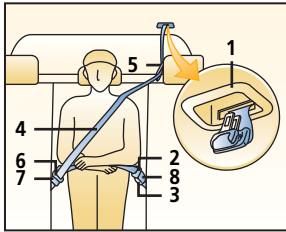
**Rear center position seat belt***

Connecting seat belt: Pull seat belt from ceiling recess (1) and connect tongue (2) to anchor (3), put belt (4) through seat belt guide (5).

Wearing seat belt: Slowly pull out lap/shoulder belt (4) and insert tongue (6) into buckle (7) until click is heard.

Unfastening seat belt: Depress buckle button (7) to release.

Tip: Leave center-rear lap portion of seat belt fastened at all times except when folding rear seat.

Stowing seat belt: Insert key or small object in anchor buckle slot (8) to release entire belt, let it fully retract, then put tongues (2) and (6) together, insert securely into recess (1).

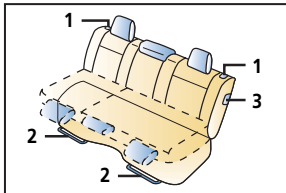
**Folding second-row seats**

Pull lever (1) up and lower seatback; when raising, lock into upright position.

Seat slide

Moving seat forward/backward, raise bar (2) and slide seat to desired position; release bar.

Seatback angle

Pull up lever (1), then lean back to desired position; release lever.

Third-row seat access

Pull lever (3) and tilt seatback and slide seat forward.

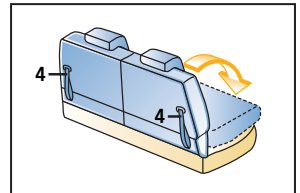
**Folding third-row seats**

Grip strap (4) and pull to fold seatback down.

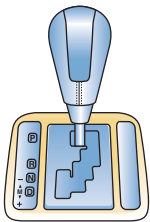
**Automatic Transaxle**

Gearshift must be in Park or Neutral to start engine; it must be in Park to remove ignition key.

P = Park

To move gearshift from Park: Press firmly on brake pedal then move the shift lever out of P.

R = Reverse

No gear engaged.

N = Neutral

For normal driving: Shifts through all forward gears automatically.

D Drive (Overdrive)

For normal driving: Shifts through all forward gears automatically.

**M (Sport A/T manual shift mode)**

Move shifter from D to M to engage manual shift mode, M will be illuminated for manual mode on

shift position indicator located in the instrument panel. Manual shifting of transmission is achieved by moving shifter back to upshift and forward to downshift, move shifter from M to D to engage automatic shift mode.

**Gear indicator**

Illuminated numeral of gear indicator located in the instrument panel

displays current gear in Automatic and Manual shift modes.

Tip: Back-up camera* automatically operates when gearshift lever is placed into reverse and is viewable via navigation display screen.

When using back-up camera, objects may be closer than they appear, please check your surroundings.

*Back-up camera feature is only available with optional Technology Package

† See Owner's Manual

Always check the Owner's Manual for more operating information and safety features

CLIMATE CONTROLS

1. Air flow selections

- = air to dash
- = air to dash and floor
- = air to floor
- = air to floor and windshield
- = air to windshield (defrost)

2. Temperature control driver/passenger

Cooler/warmer = rotate knob counterclockwise/clockwise

3. A/C = air conditioner

Press to turn on/off.

4. OFF

Press to turn system OFF.

5. Fan control

Rotate knob clockwise/ counterclockwise to increase/ decrease fan speed.

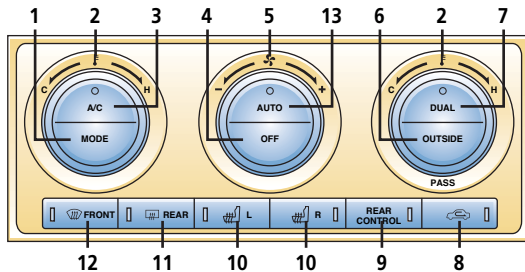

8. Air intake control

Press switch to alternate between recirculated (Indicator light on) or outside (Indicator light off) air mode.

= recirculate inside air; use for maximum cooling

⚠️ WARNING: Do not use position in cold weather, windows may fog and hamper vision.

Automatic operation

Press AUTO (13) for automatic operation; rotate outer dial to set temperature, refer to information display for air flow selection, see Owner's Manual.

☀️ Tip: Automatic climate control display viewed via information display, see Audio Systems.

6. Outside

Press Outside button (6) to display outside temperature, press again to switch display to temperature set for air conditioner.

☀️ Tip: To change from Fahrenheit to Centigrade or vice versa: Press and hold Outside button (6) for 3 seconds or more.

7. Dual

Press (7) to switch between dual (driver/passenger) or individual temperature (indicator light on) operation modes.

9. Rear control

10. Seat warmer*

Press on/off.

11. Rear window defogger

Press on/off; shuts off with ignition or automatically after 15 minutes of operation; also operates heated outside mirrors*.

12. Windshield defroster switch

Press: Fresh air position is automatically selected, A/C automatically turns ON.

Control positions for maximum defrost

Fan to maximum, temperature to maximum hot, selected.

☀️ Tip: To help prevent windshield fogging in humid weather, select before starting engine.

To prevent moisture buildup, never drive with system off. Objects placed under the front seats may interfere with air flow to the rear.

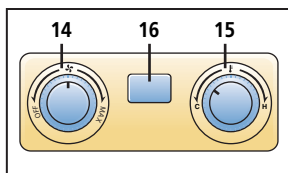

Rear climate control

Turn air conditioning (3) on; press rear control button (9), indicator light on, rear passengers can now control fan speed (14) and rear temperature (15).

Control On indicator (16) is illuminated when rear climate control is active.

When rear control switch (9) is OFF; rear climate control is not possible, temperature and airflow operates in response to front control settings.

*Denotes optional equipment

Always check the Owner's Manual for more operating information and safety features

AM / FM STEREO / CD / CD CHANGER

1. Power/Volume

Press to turn on/off; rotate to increase/decrease volume.

2. Random

Press to play CD selections in random order, press again to cancel.

3. Auto-Memory

Press and hold until a beep sound is heard; system automatically scans and temporarily stores six strong stations in each band; press again to switch to another preset station.

DISP

CD: Press repeatedly to scroll through displays.

Text*: Rotate right/left to display titles longer than 12 characters.

4. Tune

Radio: Rotate counterclockwise/clockwise for lower/higher frequency.

5. SAT*, Satellite ready capability.

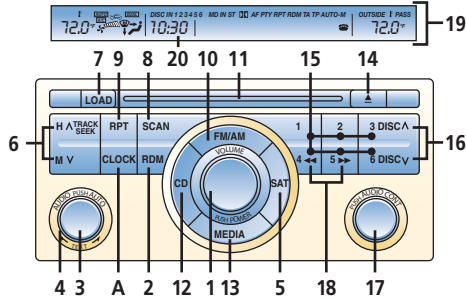

9. RPT

Press to replay current CD selection.

10. FM/AM

Press to turn radio on and select between FM1/FM2/AM station preset buttons (15).

11. CD slot

Press to play CD.

13. Media (AUX)

Select external digital devices.

Clock**

To set: With ignition in ACC or ON position, press (A) and hold until beep sounds; time flashes on display (20); press H (6) to set hour; press M (6) to set minutes, press (A) to set. To set 12hr/24hr clock: Press (17) until 12hr/24hr clock appears on display, rotate (17) to desired setting, while flashing, press to select.

6. SEEK/TRACK

Radio: Press ▲ / ▼ to automatically seek higher/lower frequency.

CD: Press ▲ / ▼ to select next track/beginning of current track.

7. LOAD*

To load multiple discs: Press and hold LOAD (7) until beep sound is heard; insert CD when "IN" is indicated on information display (19).

To eject disc: Press Eject (14).

To eject specific disc: Press and hold Eject (14) until beep sound is heard; within five seconds press the desired tray number 1-6 (15).

8. Scan

Radio: Press to sample strong stations, press again to stop at current station.

CD: Press to play first few seconds of each selection, press again to stop at current selection.

14. CD eject button

15. Memory preset buttons

To set: Tune to station, press and hold until beep sound is heard.

16. Disc ^ / v *

Press to skip to next/previous CD.

17. Audio control

Press to select ALC/BASS/TREB/FADE/BAL/BEEP/Surround* OFF/1/2/3, rotate right/left to adjust.

Tip: Automatic Level Control (ALC) automatically adjusts audio volume depending on vehicle speed.

18. Reverse ◀◀ / Fast forward ▶▶

Press to reverse/fast forward.

19. Information display

Has the following functions: Clock, audio display, automatic climate control display and outside temperature display.

*Denotes optional equipment

**See Navigation Owner's Manual for clock setting procedure if equipped with Navigation System

Steering-wheel audio controls

To increase/decrease volume: Push up/press down (21).

Press (22) to mute Audio system or activate Navigation Voice Command*. Press (23) to select AM, FM 1, FM 2, CD, RSES* and AUX mode.

Radio: Push up/press down ▲ / ▼ (24) less than one second to select next/previous preset station, for two seconds until beep sound is heard to seek next/previous station.

CD: Push up/press down ▲ (24) to select next track, ▼ (24) to repeat current track.

Navigation/Audio system*

AudioPilot* (BOSE system) Adjusts audio volume to level of noise entering vehicle; press on-screen button to turn ON/OFF.

Centerpoint* (BOSE system) Delivers multi-channel surround sound while listening to CDs.

Always check the Owner's Manual for more operating information and safety features

CARGO AREA

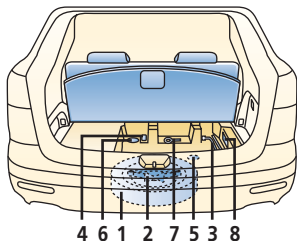

4 6 1 2 7 5 3 8

Spare tire**1. Temporary spare tire**

Stored under vehicle; to change flat tire: Follow instructions in Owner's Manual.

⚠ WARNING: Do not exceed 50 mph with temporary spare.

☀ Tip: For instructions and restrictions on use of temporary spare tire, see Owner's Manual.

2. Jack

Located behind panel

3. Lug wrench and jack lever**4. Spare tire carrier bolt socket****5. Spare tire carrier bolt**

Located behind panel

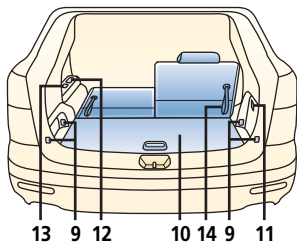
6. Spare tire hold down strap**7. Tiedown eyelet****8. Navigation DVD player**†**

13 9 12 10 14 9 11

Cargo area**9. Cargo securing loops****10. Cargo floor**

☀ Tip: Cargo floor cover can be secured in raised position by attaching third-row straps (14) to underside of floor cover.

11. Rear accessory socket**12. Rear auxiliary terminals*****13. Power outlet (AC 115V)*****Cargo light**

Located on interior side of liftgate, see Interior Lights for operation.

*Denotes optional equipment

† See Owner's Manual

Gas cap

After filling vehicle with gasoline, fully reinstall gas cap by turning clockwise until a clicking sound is heard, if gas cap is not fully installed, Check Engine light and/or gas cap indicator light may come on.

For more information on Check Engine light, see Owner's Manual.

Tire economy and tips

Check tire pressure monthly when tires are cold, use a digital tire pressure gauge for accurate tire pressure measurement.

Tires should be of the same type and size.

Maintain correct front-end alignment and tire balance; rotate tires at 5,000 or 7,500 mile intervals; see Owner's Manual for rotation chart.

Tire pressure

Decal on Driver's B-pillar provides tire pressure information.

ⓘ Tire Pressure Monitoring System (TPMS)

Warning light illuminates for a few seconds after ignition is on. If tire pressure is too low in one or more tires, warning light will illuminate and beeper will sound; flashing warning light indicates possible malfunction; dealer inspection required.

Anti-lock Braking System (ABS)

ABS automatically reduces hydraulic pressure to any wheel on the verge of locking up.

You may feel a slight pulsing of the brake pedal and hear a clicking noise; this tells you the ABS is functioning properly; increase pressure on pedal for maximum braking.

☀ Tips: Maintain constant pressure on the brake pedal. Do not pump the brakes.

ABS self test

A self-diagnostic test is performed when starting; you may feel some brake pedal pulsation and hear some noise, this is normal.

Traction Control System (TCS)

Enhances traction and safety by regulating engine torque. When TCS detects drive wheel slippage it lowers engine torque to prevent loss of traction.

Dynamic Stability Control (DSC)

Controls braking and engine torque in conjunction with ABS and TCS to help control side slip on slippery surfaces or during sudden or evasive maneuvering.

Roll Stability Control (RSC)

System determines when corrective action is needed; by controlling engine torque and braking on each wheel.

Always check the Owner's Manual for more operating information and safety features

UNDER HOOD

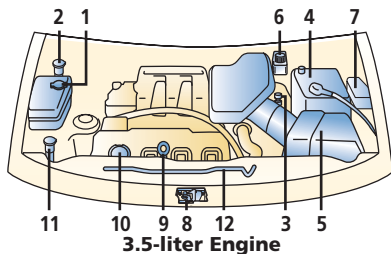
**1. Engine coolant reservoir**

Level should be between COLD FILL RANGE indicator marks.

⚠️ WARNING: Never remove coolant reservoir cap while engine is running or hot; remove only when system is cool.

2. Power steering fluid reservoir

Level should be between MIN and MAX lines.

3. Automatic transaxle fluid level dipstick**Fluid Hot scale A**

Fluid above 150°F, level must be between full and low.

Fluid Hot scale B

Cold fluid below 70°F should be close to, but not above bottom notch on dipstick.

4. Battery**5. Air filter****6. Brake fluid reservoir**

Fill to MAX mark with DOT 3 fluid; check with cap on.

7. Fuse block panel

Push latch in; lift cover.

8. Hood latch

Pull up to release hood.

9. Engine oil dipstick

Fluid should be between max. and min. on dipstick; do not fill above max.

10. Engine oil filler cap
SAE 5W-20**11. Windshield washer fluid reservoir**

Fill with windshield washer fluid.

12. Hood support rod

☀️ Tip: Check all fluids with vehicle parked on a level surface and engine off unless otherwise stated.

Break-in period

First 600 miles: Avoid heavy braking and acceleration; drive at varying road and engine speeds; engine should not exceed 3500 rpm in Park or Neutral.

☀️ Tip: Follow similar procedures with newly overhauled engine or when brakes are replaced.

Maintenance notes:

Rotate tires every 7,500 miles or sooner if needed.

Replace cabin air filter every 25,000 miles or 24 months.

Replace spark plugs every 100,000 miles.

Inspect drive belts every 105,000 miles; replace every 150,000 miles.

Replace (FL22) engine coolant at 120,000 miles.

⚠️ WARNING: Using coolant other than FL22 requires more frequent maintenance intervals.

NORMAL SERVICE INTERVALS

7,500 miles	A					
15,000 miles	A		F			
22,500 miles	A					
30,000 miles	A B		E F			
37,500 miles	A	C				
45,000 miles	A		F G			
52,500 miles	A					
60,000 miles	A B	D E F				
67,500 miles	A					
75,000 miles	A	C	F			
82,500 miles	A					
90,000 miles	A B		E F G			

☀️ Tip: For additional service intervals and complete details, see Owner's Manual.

[†] See Owner's Manual

A. Replace: Engine oil and filter[†]

Lubricate: All locks and hinges

B. Inspect: Fuel lines and hoses, brake lines, hoses and connections, steering operation and linkages, front and rear suspension and ball joints, drive-shaft dust boots

C. Replace: Air filter

D. Inspect: Hoses and tubes for emission system
Replace: Engine coolant (Other than FL22)

E. Tighten: Bolts and nuts on chassis and body

F. Inspect: Disc brakes

G. Inspect: Exhaust system and heat shields

☀️ Tip: For severe driving conditions, Owner's Manual recommends changing oil and filter at 5,000[†] miles.

Mazda Roadside Assistance

Exhilaration, liberation and inspiration, are great reasons to drive a Mazda car, truck or SUV. In addition to all the other great standard features, you also get peace of mind with our basic warranty period Emergency Roadside Assistance Plan, it's just a phone call away, 24 hours a day, 365 days a year, call **1-800-866-1998**.

Mazda "bumper-to-bumper" Limited Warranty and Powertrain Warranty

Engineers design and build every Mazda to give you driving pleasure now and far down the road. We're so confident in our quality that we cover the entire vehicle against defects in materials and workmanship for 36 months/36,000 miles, whichever comes first, plus we provide a powertrain warranty for 60 months/60,000 miles, whichever comes first.

This Quick Tips® guide is provided by Mazda North American Operations to make your Mazda ownership experience more convenient. For complete details and operating instructions, see your Owner's Manual.

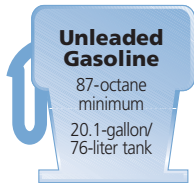

If you have any questions about your vehicle, you are invited to contact your local dealer.

Or if you need additional help, feel free to call our

Customer Assistance Center at 1-800-222-5500

Monday through Friday,

8 a.m.-4:45 p.m., Pacific

9 a.m.-5:45 p.m., Eastern/Central



www.mazdausa.com

©2007 Calcar, Quick Tips® is a trademark of Calcar, made in USA 5/07 49.795M DOT Mazda North American Operations reserves the right to change product specifications at any time without incurring obligations. 9999-95-011C-08QT