





# GENUINE MUD FLAP (FRONT)

## INSTALLATION AND USER'S INSTRUCTIONS

Thank you for purchasing a genuine Mazda accessory.  
Before removal and installation, be sure to thoroughly read these instructions.  
Please read the contents of this booklet in order to properly install and use the mud flap.  
Your safety depends on it.  
Keep these instructions with your vehicle records for future reference.

### **WARNING**

- There are several  **WARNING** and  **CAUTION** sections in this booklet concerning safety when installing or removing the mud flap. Always read and follow them in order to prevent injuries, accidents, and possible damage to the vehicle.
  -  **WARNING:** Indicates a situation in which serious injury or death could result if the warning is ignored.
  -  **CAUTION :** Indicates a situation in which bodily injury or damage to the vehicle could result if the caution is ignored.
- Do not modify the mud flap.
- Do not install the mud flap in any way other than described in the following instructions.
- If in any doubt, please ask your Mazda dealer to install the accessory in order to prevent errors in installation.
- If you have any questions about the use of the accessory, ask your Mazda dealer for proper advice before using it.
- Mazda and its suppliers are not responsible for injuries, accidents, and damage to persons and property that arise from the failure of the dealer or installer to follow these instructions.
- To ensure safety and reliability of the work, installation, removal and disposal work must be carried out by an Authorized Mazda Dealership.
- Be careful not to lose removed parts, and be sure that they are kept free from scratches, grease or other dirt.

**PART NAME: MUD FLAP (FRONT)**  
**PART NUMBER: TD11 V3 450F**  
**VEHICLE: CX-9**

### NOTE

#### To the dealer

- Please turn over these instructions to the customer after installation.

#### To the customer

- Keep these instructions after installation. The instructions may be necessary for installing other optional parts or removal of this accessory.
- Should the vehicle or this accessory be resold, always leave these instructions with it for the next owner.

# 1. PARTS

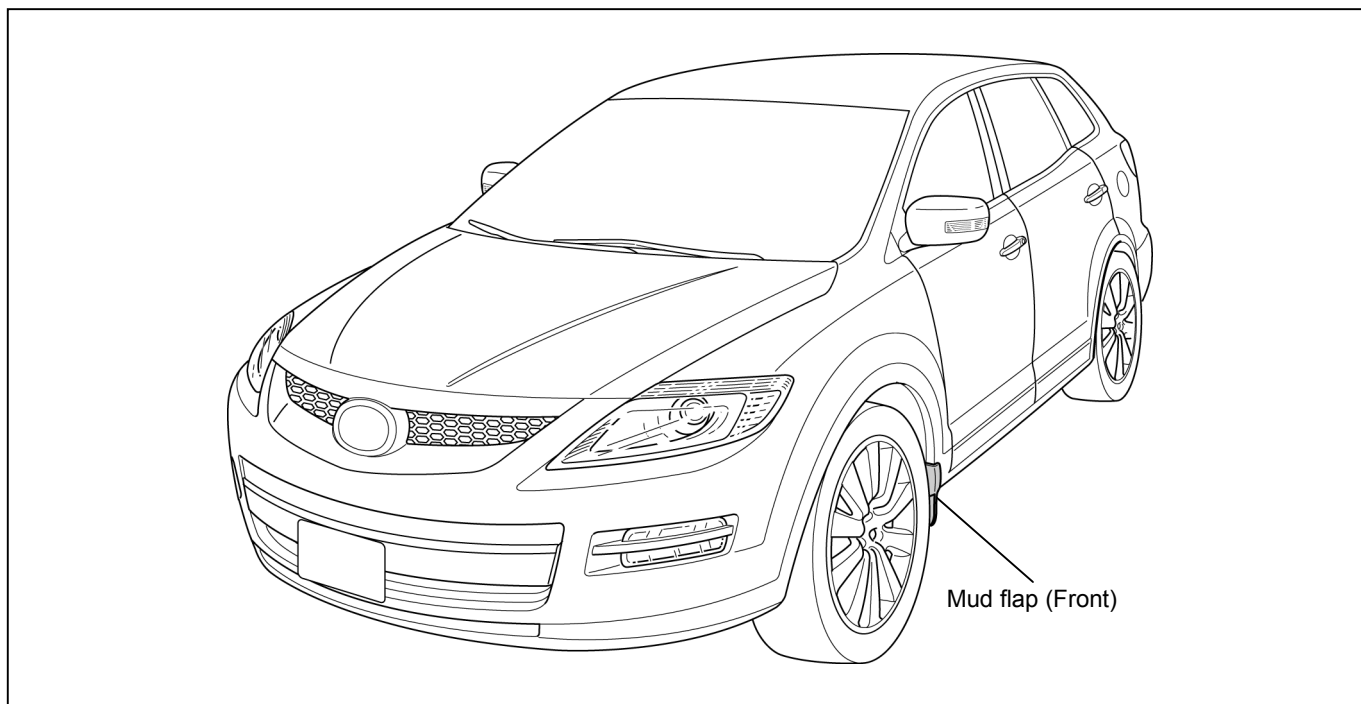

## ▼ Installation view



## ▼ Parts list

### NOTE

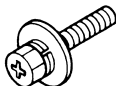
- Before installation, verify that the kit includes all the following parts and that they are free of dirt, scratches, or damage.

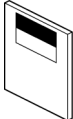
Part	Part name	Part number	Qty
	Mud flap (Front) (RH)	_____	1
	Mud flap (Front) (LH)	_____	1
	Bolt	9YA01 0502	6
	Clip nut	B092 51 861	6
	Installation and user's instructions	_____	1

## 2. BEFORE INSTALLATION

### ■ REQUIRED TOOLS

- ☆Screwdriver (Phillips)
- ☆Torque wrench
- ☆Nipper
- ☆Jack
- ☆Soft clean cloth
- ☆Protective sheet
- ☆Primer
- ☆Isopropyl alcohol (IPA)

#### ⚠ WARNING

- Park the vehicle on a flat, level surface, set the selector lever to P (AT vehicles), apply the parking brake and block the wheels so that the vehicle does not move during installation.

#### ⚠ CAUTION

Use the most appropriate (size, use) tool for each task and perform the may be damaged.

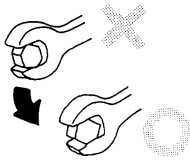

Place the removed parts and kit accessories on a protective sheet to prevent scratches.

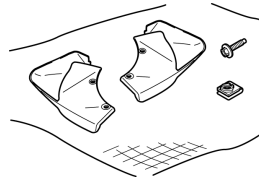

#### ⚠ CAUTION

- Always use a torque wrench when tightening bolts and tighten to the specified torque. If tightened outside the specified torque, it could result in poor fit, part damage, or other damage.
- The mud flap (Front) is made of hard plastic. Handle it with care, as it may be deformed or discolored if it contacts solvents such as paint thinner or comes close to flame.

#### NOTE

- Refer to the applicable Workshop Manual for removal and installation of vehicle parts. Not following the procedures for removal/installation in the Workshop Manual could result in an accident or vehicle malfunction.

### 3. MUD FLAP (FRONT) INSTALLATION

#### NOTE

- The figure shows the left side, however, perform the same procedure for the right side.

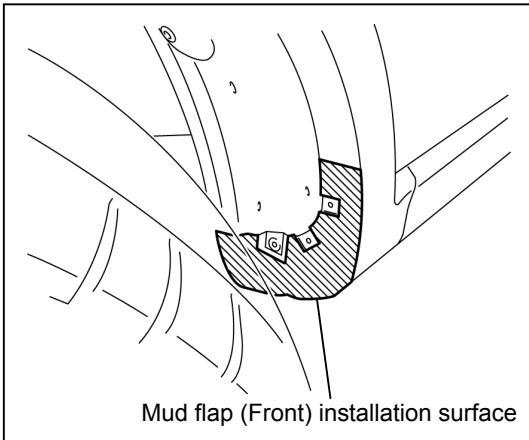

1. Use a soft cloth dampened with IPA (isopropyl alcohol) to clean the surface of the vehicle where the mud flap (front) is to be installed.

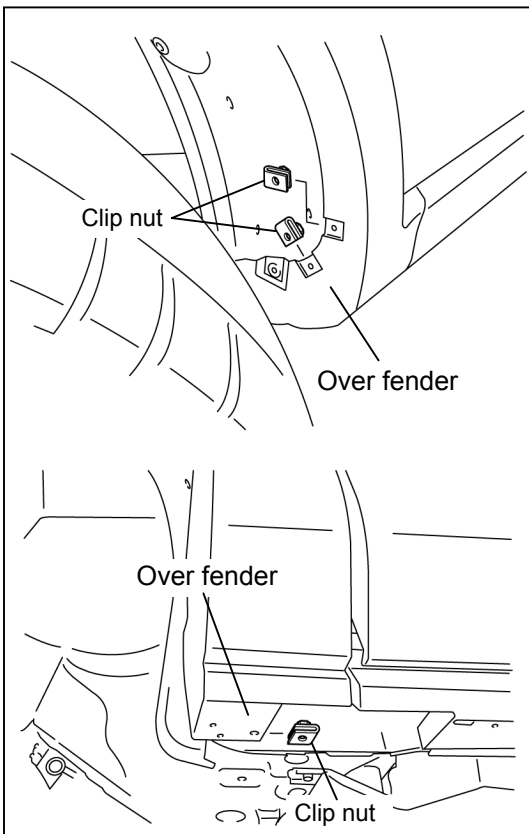

2. Align the over fender holes, and install the kit clip nuts (3).

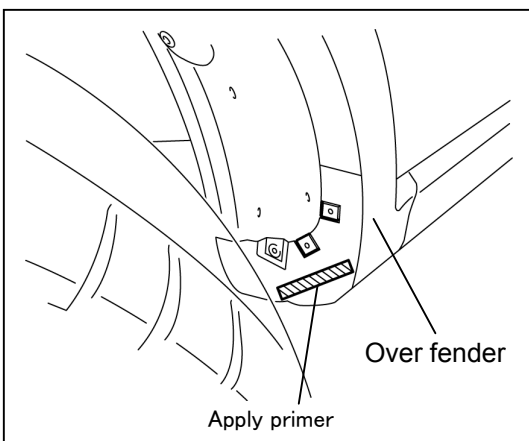

3. Apply primer to the double-sided adhesive tape adhesion surface of the mud flap for the over fender.

#### ⚠ CAUTION

- Always apply PAC primer to provide the necessary adhesive strength when adhering.
- Do not apply PAC primer to areas outside of the application area due to the area becoming discolored.

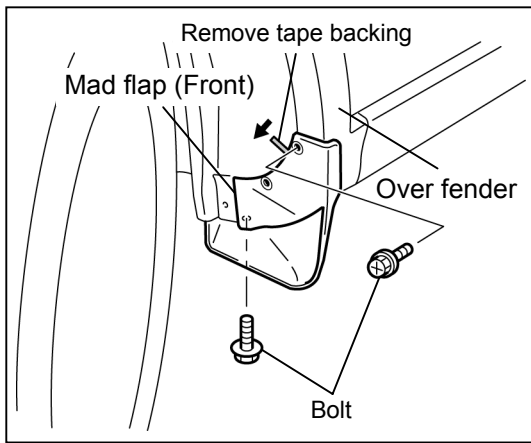

4. Temporarily tighten the kit bolts (2).
5. Remove the double-sided adhesive tape backings from the mud flap (front) and affix securely.

**⚠ CAUTION**

- Do not separate the taped areas once the tape has adhered, otherwise the subsequent adhesion performance will be greatly reduced.

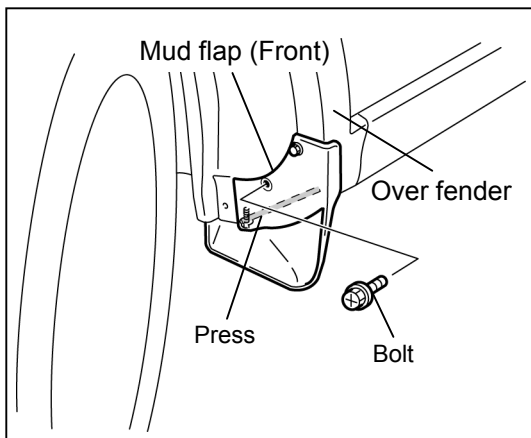

6. Temporarily tighten the kit bolts (1).
7. Press the mud flap (front) to the over fender while verifying that there are not gaps.
8. Apply sufficient pressure to the double adhesive tape from the exterior side of the mud flap (front).

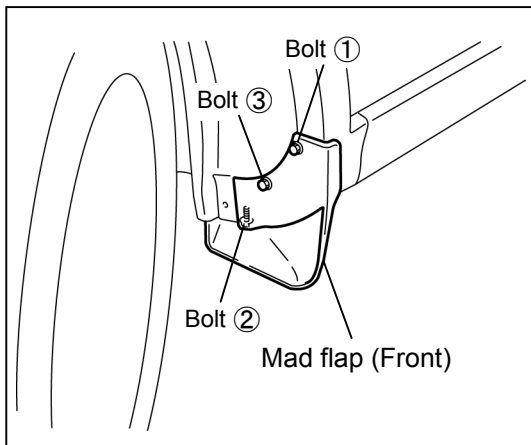

9. Install the mud flap (front) in the order shown in the figure on the left while pressing it against the over fender.

**Tightening torque**

**Bolt : 0.8—1.2 N·m {8.2—12.2 kgf·cm · 7.1—10.6 in·lbf }**

**⚠ CAUTION**

- Make sure the bolt is tightened securely. Make sure to tighten to the specified torque. If tightened outside the specified torque, the mud flap (front) could be damaged or fall off.

## 4. CONFIRMATION AFTER INSTALLATION

1. Be sure that there are no excessive gaps.

- If there are any gaps, loosen all the bolts and then retighten them in the order of top, middle, and bottom while pressing the mud flap (front) against the vehicle.

2. Be sure that all bolts are securely tightened.

## 5. MUD FLAP (FRONT) PRECAUTIONS

### CAUTION

- If gasoline, engine coolant, or battery fluid adheres to the painted surface of the resin parts, it will cause discoloration, stains, or paint peeling. Wipe it off with a soft cloth immediately.
- Don't drive through an automatic car wash; it may damage the mud flap (front).
- Do not use car polish containing wax compounds. Otherwise, the paint could be damaged.
- If the vehicle height is lowered due to the vehicle being at maximum passenger or cargo capacity, decrease the vehicle speed when parking on a road shoulder or entering/leaving a road shoulder or bump. Otherwise, the mud flaps (front) could be damaged.

**INSTALLATION  
INSPECTION  
SHEET**

**CX-9**

**MUD FLAP (FRONT)**

**TD11 V3 450F**

**Inspection after installation**

- Inspect the installed / reinstalled parts for the following items.

Inspection Parts	Check Item (O)			
	Clearance/Fit	Scratches / Dirt	Installation / Engagement	Fastener, bolt tightening
Mud flap (Front)	<input type="radio"/>	<input type="radio"/>	<input type="radio"/>	<input type="radio"/>
Over fender	<input type="radio"/>	<input type="radio"/>	<input type="radio"/>	<input type="radio"/>

Installation inspection sheet for mud flap (Front)

Date _____, _____, _____				
VIN. _____				
Approved		Checked		Person in charge

The term of validity for this sheet: 12 months