

MONITOR WITH DVD RECEIVER

## DDX9907XR

## DDX9707S

MONITOR WITH RECEIVER

## DMX957XR

## DMX907S

## DMX9707S

---

## INSTRUCTION MANUAL

JVCKENWOOD Corporation

- Updated information (the latest Instruction Manual, system updates, new functions, etc.) is available from  
<<https://www.kenwood.com/cs/ce/>>.
- The Instruction manual is subject to change for modification of specifications and so forth. Be sure to download the latest edition of the Instruction manual for reference.  
<<https://manual.kenwood.com/edition/im404/>>

**Take the time to read through this instruction manual.**

**Familiarity with installation and operation procedures will help you obtain the best performance from your new receiver.**

### **For your records**

Record the serial number, found on the top of the unit, in the spaces designated on the warranty card, and in the space provided below. Refer to the model and serial numbers whenever you call upon your KENWOOD dealer for information or service on the product.

Model DDX9907XR / DDX9707S / DMX957XR / DMX907S / DMX9707S Serial number \_\_\_\_\_

***US Residence Only***

### **Register Online**

Register your KENWOOD product at [www.kenwood.com/usa/](http://www.kenwood.com/usa/)

## Important Notice on Software

### Software License on This Product

The software embedded in this product comprises a number of independent software components, each of which is copyrighted by JVCKENWOOD Corporation or by a third party. This product uses software components that are based on an End-User License Agreement (hereinafter called "EULA") stipulated by JVCKENWOOD Corporation and by third parties. The EULA dictates the availability of the source codes of free-software components as a prerequisite to distributing them in executable form under the terms of the GNU General Public License or the Lesser General Public License (hereinafter called "GPL/LGPL"). To get information about the software components that are subject to the terms of the GPL/LGPL, please visit the following Website:

Website URL <https://www2.jvckenwood.com/gpl/>

Queries concerning the contents of the source code or the like will not be accepted.

Please note that software components based on a EULA that is not subject to the terms of the GPL/LGPL or those that have been developed or created by JVCKENWOOD Corporation will be excluded from the scope of source code disclosure.

Because licenses to use software components distributed under the GPL/LGPL are offered to the customers for free of charge, no warranty is granted to the customers, whether explicitly or implicitly, to the extent of the applicable laws. Unless otherwise stipulated by the applicable laws or agreed upon in writing, the copyright holders or those who are entitled to modify and redistribute the software components are not held responsible for any and all damages resulting from their use or from inability to use them. For more information about the terms of use of the software components, required items of compliance and so on, please refer to the GPL/LGPL.

Customers wishing themselves to use a software component that is subject to the GPL/LGPL embedded in this product are encouraged to read the terms of the corresponding license before use. Because each individual license is prescribed by a third party other than

JVCKENWOOD Corporation, the original (English) of the license is presented.

## EULA

### Software License Agreement

JVCKENWOOD Corporation (hereinafter called "Licensor") holds either the copyright to the embedded software or the right to sublicense it. This agreement establishes the conditions under which the customer uses this "Licensed Software." The customer shall agree to the terms of this license agreement before proceeding to use Licensed Software.

This agreement is deemed to have taken effect when the customer (hereinafter called "User") has used a product implementation of Licensed Software.

The Licensed Software may contain software Licensor has been licensed to use by third parties directly or indirectly. Some third parties may have terms of use prescribed for their customers, apart from this Software License Agreement. This agreement does not apply to such software. Be sure to consult "Important Notice on Software" as presented separately.

#### Article 1 (General)

Licensor grants to User a non-exclusive, non-assignable right of use Licensed Software within the country where the User purchases the Product (hereinafter the "Country") (except for the exception provided for in Paragraph 1, Article 3).

#### Article 2 (Right of Use)

1. The rise of use granted under this agreement is the right to use Licensed Software in this product.
2. User may not duplicate, copy, modify, add to, translate or otherwise alter, or loan licensed Software and the associated literature in whole or in part.
3. Use of Licensed Software is limited to a private extent, and Licensed Software may not be distributed, licensed or sublicensed for any purposes whatsoever, including commercial use.
4. User shall use Licensed Software as per the instruction manual or instructions given in the help file and may not use or duplicate data in violations of the regulations of the Copyright Law or other governing laws by using Licensed Software in whole or in part.

### **Article 3 (Terms of License)**

1. In assigning this product, User may not retain the original copy of the embedded Licensed Software (including associated literature, updates and upgrades) and any duplicates and associated literature with regard to the license to use Licensed Software. User may transfer Licensed Software only to the condition of binding the assignee to abide by the terms of this Software License Agreement.
2. User may not reverse-engineer, disassemble, decompile or otherwise analyze the source code of Licensed Software.

### **Article 4 (Rights to Licensed Software)**

All rights to Licensed Software and the associated literature, including copyrights, shall reside with Licensor or the original right holder who has granted the Right of Use and right to sublicense to Licensor (hereinafter referred to as "Original Right Holder"), and User does not have any rights other than Right of Use granted hereunder with regard to Licensed Software and the associated literature.

### **Article 5 (Exemption Granted to Licensor)**

1. Licensor and Original Right Holder do not assume any responsibility for damages caused to User or third parties resulting from the exercise by User of the license granted hereunder, unless otherwise provided by any law to the contrary.
2. Licensor does not warrant Licensed Software to be merchantable, compatible and fit for specific purposes.

### **Article 6 (Responsibility for Third Parties)**

If disputes over the infringement of third parties' intellectual property rights, such as copyrights and patent rights, arise out of the use of Licensed Software by User, User shall resolve these disputes at User's own expenses while keep Licensor and Original Right Holder harmless.

### **Article 7 (Secrecy Obligation)**

User shall keep confidential Licensed Software provided hereunder, information contained in the associated literature or the like and those provisions of this agreement not yet in public knowledge and may not disclose or leak these to third parties without prior written consent from Licensor.

### **Article 8 (Cancellation of the Agreement)**

Licensor reserves the right to cancel this agreement forthwith and claim compensation from User for the damages caused by such cancellation when User:

- (1) Breaches any of the provisions of this agreement, or
- (2) Has received a petition for seizure, provisional seizure, provisional disposition or any other kind of compulsory execution.

### **Article 9 (Destruction of Licensed Software)**

If this agreement is terminated under the provision of the foregoing paragraph, User shall destroy Licensed Software, along with all associated literature and its duplicates, within two (2) weeks from the date of termination.

### **Article 10 (Copyright Protection)**

1. Copyrights and all other intellectual property rights relating to Licensed Software shall reside with Licensor and Original Right Holder and in no circumstances with User.
2. User shall abide by the laws relating to copyrights and intellectual property rights in using Licensed Software.

### **Article 11 (Export Control)**

1. Licensed Software and the associated literature or the like may not be exported to places outside the Country (including transmission outside the Country over the Internet or the like).
2. User agrees that Licensed Software is subject to export controls imposed by the Country and the United States of America.
3. User agrees to comply with all the international and domestic laws that apply to this software (U.S. Export Administration Regulations and regulations established by the U.S., the Country and their governmental agencies regarding usage by end users and export destinations).

### **Article 12 (Miscellaneous)**

1. Even if this agreement is invalidated in part by law, all other provisions shall remain in effect.
2. Licensor and User shall consult each other in good faith to resolve any matters not provided for in this agreement or questions arising from the interpretation of this agreement.
3. Licensor and User agree that this agreement is governed by the law of Japan and that all disputes involving claims and obligations that may arise out of this agreement will be settled by arbitration at the Tokyo District Court as the court of first instance.

# Contents

## **Before Use 6**

Precautions.....	6
How to read this manual .....	7

## **Basic Operations 8**

Functions of the Buttons on the Front Panel ...	8
Turning on the Unit .....	10
Initial Settings.....	10
Adjusting the volume .....	12
Display Adjustment .....	12
Viewing Angle .....	13
Touch screen operations .....	13
HOME screen descriptions.....	14
Popup menu .....	14
Source selection screen description.....	15
Source control screen descriptions .....	17
List screen .....	18

## **Widget 19**

Widget.....	19
Multi Widget.....	19
Photo Frame Widget .....	21
Widget SETUP .....	21

## **Disc 23**

Playing a disc .....	23
DVD/VCD Basic Operation .....	23
Music CD/Disc media Basic Operation .....	25
File search Operation .....	26
DVD Disc Menu Operation.....	27
DVD SETUP .....	28

## **APPS 29**

Wireless Mirroring Operation.....	29
USB Mirroring Operation.....	29
Apple CarPlay Operation .....	31
Android Auto Operation.....	34

## **USB 37**

Connecting a USB device .....	37
USB Basic Operation.....	37
Search Operation.....	39

## **iPod/iPhone 40**

Preparation .....	40
iPod/iPhone Basic Operation .....	40
Search Operation.....	41

## **Radio 43**

Radio Basic Operation .....	43
Memory Operation.....	44
Selecting Operation .....	45
Traffic Information .....	45

## **HD Radio™ Tuner 46**

HD Radio Tuner Basic Operation.....	46
Receive Mode .....	48
Memory Operation .....	48
Selecting Operation .....	48
Bookmark.....	50
Alert Message .....	51

**SiriusXM® 52**

SiriusXM® Basic Operation .....52  
Storing Channels in Preset Memory.....54  
Preset select .....54  
Direct search .....54  
Category/Channel search.....55  
Replay .....55  
TuneMix™ .....56  
SmartFavorites, TuneStart™ .....56  
TuneScan™ .....56  
Traffic & Weather Now™ .....57  
Content Alerts.....57  
SportsFlash™ .....58  
SiriusXM SETUP .....58

**Bluetooth Control 64**

Information for using Bluetooth® devices.....64  
Register the Bluetooth device .....65  
Bluetooth Setup.....66  
Playing the Bluetooth Audio Device .....68  
Using the Hands-Free Unit.....70  
Hands-Free Setup.....75

**Other External Components 76**

View Camera .....76  
Use Dashboard Camera.....78  
External audio/video players (AV-IN).....79  
OEM Features Operation .....79

**Setup 81**

Monitor Screen Setup .....81  
System Setup .....81  
User Interface Setup.....82  
Special Setup .....83  
Display Setup.....84  
AV Setup .....86

**Controlling Audio 87**

3-way speaker system setup .....87  
Speaker / X'over setup .....88  
Controlling General Audio .....90  
Equalizer Control .....90  
Volume Offset.....91  
Zone Control .....92  
Sound Effect .....93  
Listening Position / DTA .....94  
Audio Setup memory .....95

**Remote control 96**

Battery Installation.....96  
Functions of the Remote control Buttons .....96

**Connection/Installation 99**

Before Installation .....99  
Installing the unit..... 101

**Troubleshooting 109**

Problems and Solutions ..... 109  
Error Messages ..... 110

**Appendix 112**

Playable Media and Files..... 112  
Region Codes in the World ..... 114  
DVD Language Codes..... 115  
Specifications..... 116  
About this Unit ..... 119

# Before Use

## Precautions

### ▲ WARNINGS

#### ■ To prevent injury or fire, take the following precautions:

- To prevent a short circuit, never put or leave any metallic objects (such as coins or metallic tools) inside the unit.
- Do not watch or fix your eyes on the unit's display when you are driving for any extended period.
- If you experience problems during installation, consult your KENWOOD dealer.

#### ■ Precautions on using this unit

- When you purchase optional accessories, check with your KENWOOD dealer to make sure that they work with your model and in your area.
- You can select a language to display menus, audio file tags, etc. See **User Interface Setup (P.82)**.
- The Radio Data System or Radio Broadcast Data System feature won't work in areas where the service is not supported by any broadcasting station.

#### ■ Protecting the monitor

- To protect the monitor from damage, do not operate the monitor using a ball point pen or similar tool with a sharp tip.

#### ■ Cleaning the unit

- If the faceplate of this unit is stained, wipe it with a dry soft cloth such as a silicon cloth. If the faceplate is stained badly, wipe it with a cloth moistened with neutral cleaner, then wipe it again with a clean soft dry cloth.

#### NOTE

- Applying spray cleaner directly to the unit may damage its mechanical parts. Wiping the faceplate with a hard cloth or using a volatile liquid such as thinner or alcohol may scratch the surface or erase the screened print.

#### ■ Lens fogging

When you turn on the car heater in cold weather, dew may form on the lens in the disc player of the unit due to condensation. This condensation on the lens (also called lens fogging) may not allow discs to play. In such a situation, remove the disc and wait for the dew to evaporate. If the unit still does not operate normally after a while, consult your KENWOOD dealer.

#### ■ Precautions on handling discs

- Do not touch the recording surface of the disc.
- Do not stick tape etc. on the disc, or use a disc with tape stuck on it.
- Do not use disc type accessories.
- Clean the disc from the center toward the outside rim.
- When removing a disc from this unit, pull it out horizontally.
- If the disc center hole or outside rim has burrs, use the disc only after removing the burrs with a ballpoint pen etc.
- Discs that are not round cannot be used.



- 8-cm (3 inch) discs cannot be used.
- Discs with coloring on the recording surface or discs that are dirty cannot be used.
- This unit can only play the following types of CDs.



- This unit may not correctly play discs which do not have the mark.
- You cannot play a disc that has not been finalized. (For the finalization process, see your writing software and your recorder's instruction manual.)

## Acquiring GPS signal

The first time you turn on this unit, you must wait while the system acquires satellite signals for the first time. This process could take up to several minutes. Make sure your vehicle is outdoors in an open area away from tall buildings and trees for fastest acquisition.

After the system acquires satellites for the first time, it will acquire satellites quickly each time thereafter.

## About GLONASS

This unit uses Global Navigation Satellite System (GLONASS) in addition to GPS.

Combining GPS and GLONASS can refine positioning accuracy than using GPS only.

## Caution for Smartphone Users

Simultaneously running multiple applications on your smartphone while screen sharing places heavy demand on the microprocessor of the phone, potentially affecting communication and performance.

For best results while pairing with your KENWOOD receiver, please be sure to close any unused applications.

## How to read this manual

- The screens and panels shown in this manual are examples used to provide a clear explanation of operations. For this reason, they may be different from the actual screens or panels, or some display patterns may be different from the actual ones.
- **Display language:** English is used for the purpose of explanation. You can select a display language from the **SETUP** menu. See **User Interface Setup (P.82)**.

# Basic Operations

## Functions of the Buttons on the Front Panel

### DDX9907XR / DDX9707S

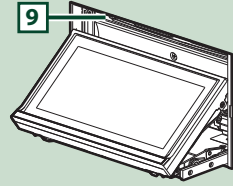
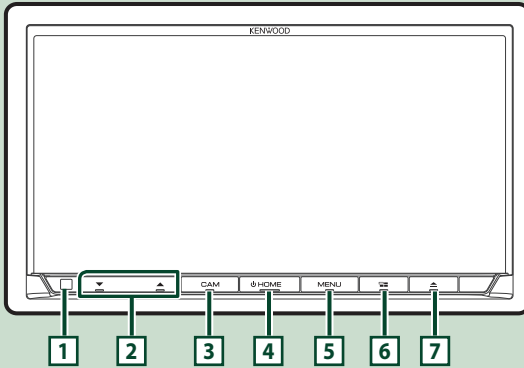

### DMX957XR / DMX907S / DMX9707S

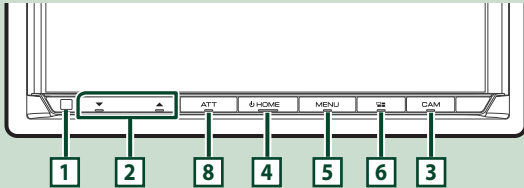



**NOTE**

- The panels shown in this manual are examples used to provide a clear explanation of operations. For this reason, they may be different from the actual panels.

Number	Name	Motion
1	Remote Sensor	<ul style="list-style-type: none"> <li>• Receives the remote control signal.</li> </ul>
2	▼, ▲ (Volume)	<ul style="list-style-type: none"> <li>• Adjusts the volume. The volume will go up to 15 when you keep pressing ▲. (P.12)</li> </ul>
3	CAM	<ul style="list-style-type: none"> <li>• Switches view camera display on/off. The camera whose view is displayed first changes according to the "Camera Setup" setting and the shift lever position in the shift gate. The camera whose view was displayed last is kept and the same camera view will be displayed the next time. If its assignment setting is changed, the rear camera view is displayed.</li> <li>• Pressing and holding turns the screen off. (DDX9907XR / DDX9707S)</li> <li>• Pressing and holding displays the Angle Adjust screen. (DMX957XR only)</li> </ul>
4	HOME	<ul style="list-style-type: none"> <li>• Displays the HOME screen (P.14).</li> <li>• Pressing for 1 second turns the power off.</li> <li>• When the power is off, turns the power on.</li> </ul>
5	MENU	<ul style="list-style-type: none"> <li>• Displays the popup menu screen.</li> <li>• Pressing for 1 second switches attenuation of the volume on/off. (DDX9907XR / DDX9707S)</li> <li>• Pressing for 1 second turns the screen off. (DMX957XR / DMX907S / DMX9707S)</li> </ul>
6		<ul style="list-style-type: none"> <li>• Displays the APP (Apple CarPlay/Android Auto/Wireless Mirroring) screen.</li> <li>• Pressing and holding displays the Voice Recognition screen (P.72).</li> <li>• When neither Apple CarPlay, Android Auto, nor a Bluetooth Hands-Free phone is connected, pressing and holding displays Bluetooth pairing waiting dialog. (P.65)</li> </ul>
7	▲	<ul style="list-style-type: none"> <li>• Displays the Angle Adjust screen. <ul style="list-style-type: none"> <li>– <b>DISC EJECT</b>: Ejects the disc.</li> </ul> </li> <li>• When the panel is opened, closes the panel.</li> <li>• To forcibly eject the disc, press it for 2 seconds and then touch <b>DISC EJECT</b> after the message is displayed.</li> </ul>
8	ATT	<ul style="list-style-type: none"> <li>• Switches attenuation of the volume on/off.</li> </ul>
9	Disc insert slot	<ul style="list-style-type: none"> <li>• A slot to insert a disc media. (DDX9907XR / DDX9707S only)</li> </ul>

## Turning on the Unit

The method of turning on is different depending on the model.

- 1 Press the **HOME** button.

DDX9907XR / DDX9707S

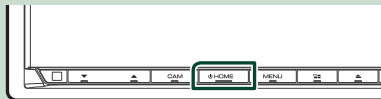

DMX957XR / DMX907S / DMX9707S



➤ The unit is turned on.

### ● To turn off the unit:

- 1 Press the **HOME** button for 1 second.

#### NOTE

- If it is your first time to turn the unit on after installation, it will be necessary to perform Initial SETUP (P.10).

## Initial Settings

### Initial SETUP

Perform this setup when you use this unit first time.

- 1 Set each item as follows.

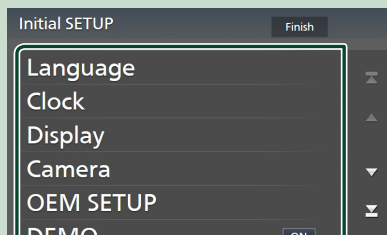

#### ■ Language

Select the language used for the control screen and setting items. Default is "American English(en)".

- ① Touch **Language**.
- ② Touch **Language Select**.
- ③ Select the desired language.
- ④ Touch .

For details, see **User Interface Setup (P.82)**.

#### ■ Clock

Sets the synchronization of the clock and adjusts it.

For details, see **Calendar/clock settings (P.11)**.

#### ■ Display

Set the key illumination color.

If it is hard to see the image on the screen even, adjust the viewing angle.

- ① Touch **Display**.
- ② Touch **Key Color**.
- ③ Select the desired color.
- ④ Touch .

(DDX9907XR / DDX9707S / DMX957XR only)

- ⑤ Touch **Display Adjustment**.
- ⑥ Adjust a viewing angle and a tilt position.
- ⑦ Touch .

For details, see **Display Adjustment (P.12)**.

(DMX907S / DMX9707S only)

- ⑤ Touch **Viewing Angle**.
- ⑥ Select a viewing angle.
- ⑦ Touch .

For details, see **Viewing Angle (P.13)**.

For details, see **Display Setup (P.84)**.

### ■ Camera

Set the parameters for the camera.

- ① Touch **Camera**.
- ② Set each item and touch .

For details, see **Camera Setup (P.76)**.

### ■ OEM SETUP

This function requires a commercial adaptor. Consult your KENWOOD dealer for details.

### ■ DEMO

Set the demonstration mode. Default is "ON".

## 2 Touch Finish.

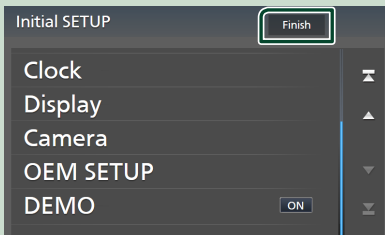

### NOTE

- These settings can be made from the SETUP menu. See **Setup (P.81)**.

## Calendar/clock settings

### 1 Press the **MENU** button.

- Popup menu appears.

### 2 Touch **SETUP**.

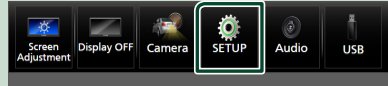

- SETUP Menu screen appears.

### 3 Touch **User Interface**.

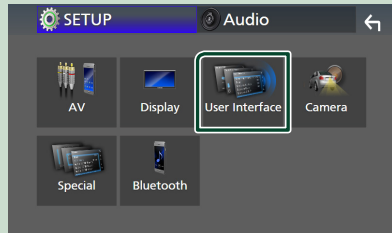

- User Interface screen appears.

### 4 Set each item as follows.

Scroll the page to show hidden items.

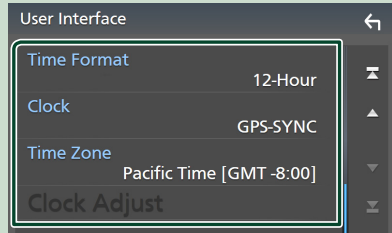

#### ■ Time Format

Select the time display format.

**12-Hour** (Default)/**24-Hour**

#### ■ Clock

**GPS-SYNC** (Default): Synchronizes the clock time with the GPS.

**Manual**: Set the clock manually.

#### ■ Time Zone

Select the time zone.

#### ■ Clock Adjust

If you select **Manual** for Clock, adjust the date and time manually. **(P.83)**

**NOTE**

- Please set the date and time. If they are not set, some functions may not work.

## Adjusting the volume

You can adjust the volume (0 to 40). Press ▲ to increase, and press ▼ to decrease. Holding ▲ increases the volume continuously to level 15.

### DDX9907XR / DDX9707S



### DMX957XR / DMX907S / DMX9707S



## Display Adjustment (DDX9907XR / DDX9707S / DMX957XR)

### DDX9907XR / DDX9707S

- 1 Press the ▲ button.
  - Display Adjustment screen appears.

### DMX957XR

- 1 Press and hold the CAM button.
  - Display Adjustment screen appears.

### DDX9907XR / DDX9707S

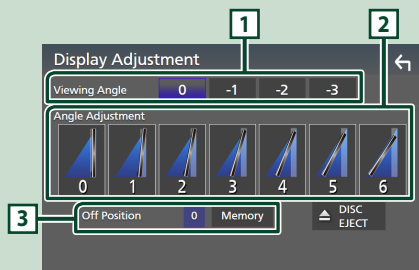

### DMX957XR

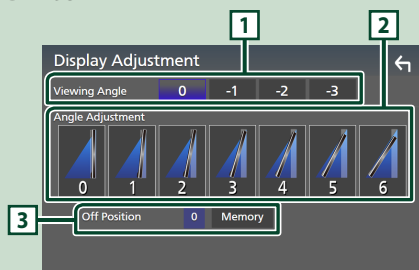

#### 1 Viewing Angle

You can adjust the viewing angle when the image on the screen is difficult to see evenly. The smaller the (negative) value, the more whitish the image on the screen looks. "0" (Default)"/"-1"/"-2"/"-3"

#### 2 Angle Adjustment

Select a tilt position you want to set up. Default is "0".

### 3 Off Position

You can store the current monitor angle as the angle during power off. Touch **Memory** when the desired angle is selected.

## Viewing Angle (DMX907S / DMX9707S)

You can adjust the viewing angle when the image on the screen is difficult to see evenly. The smaller the (negative) value, the more whitish the image on the screen looks.

#### 1 Press the **MENU** button.

➤ Popup menu appears.

#### 2 Touch **SETUP**.

#### 3 Touch **Display**.

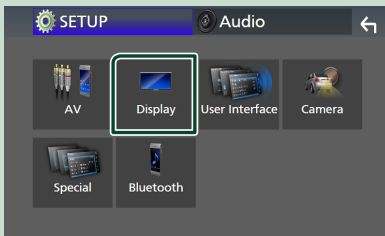

➤ Display screen appears.

#### 4 Touch **Viewing Angle**.

#### 5 Select an angle you want to set up.

Default is "0". (P.84)

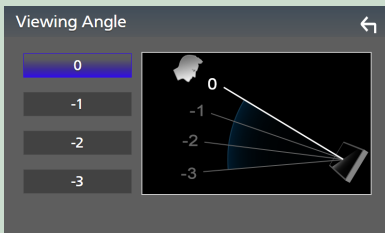

## Touch screen operations

To perform operations on the screen, you need to touch, touch and hold, flick or swipe to select an item, display a setting menu screen or change pages.

#### ● Touch

Touch the screen gently to select an item on the screen.

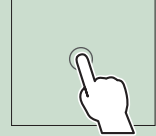

#### ● Touch and hold

Touch the screen and keep your finger in place until the display changes or a message is displayed.

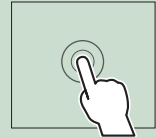

#### ● Flick

Slide your finger quickly to the left or right on the screen to change the page. You can scroll a list screen by flicking up/down on the screen.

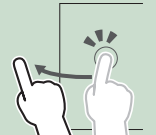

#### ● Swipe

Slide your finger up or down on the screen to scroll the screen.

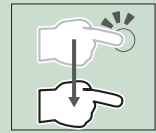

## HOME screen descriptions

Most functions can be performed from the HOME screen.



- 1 • Widget (P.19)
  - You can change the widget by flicking left or right on the widget area.
  - Touch the widget to display the detailed screen.
- 2 • Displays the source selection screen. (P.15)
- 3 • Short-cut playback source icons (P.16)

## Display the HOME screen

- 1 Press the **HOME** button.

DDX9907XR / DDX9707S



DMX957XR / DMX907S / DMX9707S



- HOME screen appears.

## Popup menu

- 1 Press the **MENU** button.
  - Popup menu appears.
- 2 Touch to display the popup menu.



The contents of the menu are as follows.

	• Displays the Screen Adjustment screen. (P.81)
	• Turns the display off. (P.15)
	• Displays the view camera screen. (P.76)
	• Displays the SETUP Menu screen. (P.81)
	• Displays the Audio screen. (P.87)
	• Displays the control screen of current source. Icon feature differs depending on the source. This icon is for USB source.
	• Close the popup menu.
	• Displays the Android Auto device list. This icon appears only when Android Auto is connected and two or more devices can be used as Android Auto source.
1	• Short-cut source icons: The source changes to the one you have set with a short-cut. For the short-cut setting, refer to <b>Customize Short-cut source icons on HOME screen</b> (P.16).

## Turn off the screen

- 1 Select **Display OFF** on the popup menu.

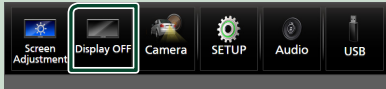

### NOTE

- Touch the display to turn on the screen.
- To display the clock while the screen is off, it is necessary to set "OSD Clock" to "ON". (P.84)

## Source selection screen description

You can display icons of all playback sources and options on the source selection screen.

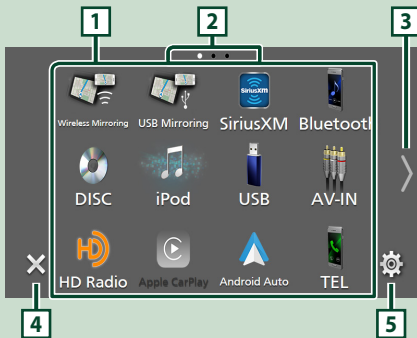

- 1 • Changes playback sources.  
For playback sources, see **Select the playback source (P.15)**.
- 2 • Page indication
- 3 • Changes pages. (Touch / )  
You can also change pages by flicking left or right on the screen.
- 4 • Returns to the previous screen.
- 5 • Displays the SETUP Menu screen. (P.81)

## Select the playback source

- 1 Press the **HOME** button.  
➤ HOME screen appears.

- 2 Touch .

From the screen, you can select the following sources and functions.

	• Switches to the Apple CarPlay screen from the connected iPhone. (P.31)
	• Switches to the Android Auto screen from the connected Android smartphone. (P.34)
	• Displays the Hands Free screen. (P.70) When neither Apple CarPlay, Android Auto, nor a Bluetooth Hands-Free phone is connected, displays Bluetooth pairing waiting dialog.*1 (P.65)
	• Switches to the Radio broadcast.*2 (P.43)
	• Switches to the HD Radio broadcast.*3 (P.46)
	• Switches to the SiriusXM® satellite radio broadcast. (P.52)
	• Plays a Bluetooth audio player. (P.68)
	• Plays a disc.*4 (P.23)
	• Plays an iPod/iPhone. (P.40)
	• Plays files on a USB device. (P.37)
	• Switches to an external component connected to the AV-IN input terminal.*5 (P.79)
	• Switches to the Wireless Mirroring screen from the connected Android smartphone. (P.29)
	• Switches to the USB Mirroring screen from the connected iPhone/Android smartphone. (P.29)
	• Displays the Audio screen. (P.87)
	• Puts the unit in standby. (P.16)

## Basic Operations

• For sources and information displayed when an ADS adapter is connected, see **OEM Features Operation (P.79)**.

\*1 When connecting as Apple CarPlay or Android Auto, it works as a phone provided in Apple CarPlay or Android Auto. If Apple CarPlay or Android Auto are connected during talking by the Bluetooth device or iDataLink phone, the current call will be continued.

\*2 DDX9707S / DMX9707S only

\*3 DDX9907XR / DMX957XR / DMX907S only

\*4 DDX9907XR / DDX9707S only

\*5 CA-C3AV (optional accessory) is connected to the AV-IN input terminal for visual. **(P.105)**

### To select the playback source on the HOME screen

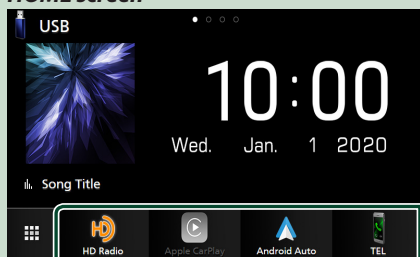

The 4 items displayed on the source selection screen with large icons are shown on the HOME screen.

You can change the items displayed on this area by customizing the source selection screen. **(P.16)**

### To select the playback source on the source control screen

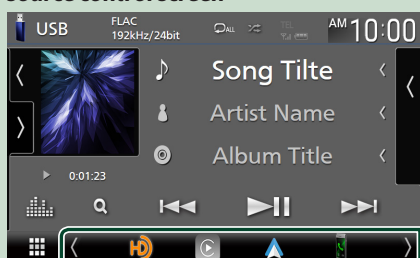

Display source selection icons by touching  or flicking left or right on the source control screen, then select a playback source.

## Put the unit in standby

**1** Press the **HOME** button.

➤ HOME screen appears.

**2** Touch .

**3** Touch **STANDBY**.

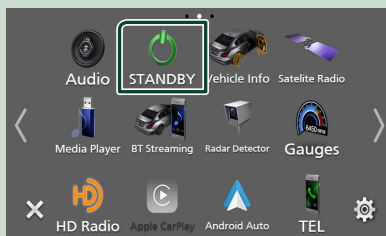

## Customize Short-cut source icons on HOME screen

You can arrange the positions of the source icons as you like.

**1** Press the **HOME** button.

➤ HOME screen appears.

**2** Touch .

**3** Touch and hold the icon which you want to move in the customizing mode.

**4** Drag the icon to the desired position.



Changes the page

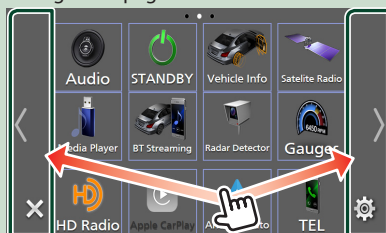



## Source control screen descriptions

There are some functions which can be performed from most screens.

### Indicators

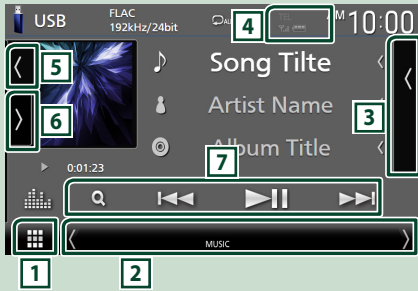

### Short-cut source icons



#### 1 All sources icon

Displays the source selection screen. (P.15)

#### 2 Secondary screen

- **◀/▶**: The Secondary screen changes to another one every time you touch it. You can also change the Secondary screen by flicking left or right on the screen.
- **Indicators**: Displays the current source condition and so on.
  - **ATT**: The attenuator is active.
  - **DUAL**: The dual zone function is active.
  - **MUTE**: The mute function is active.
  - **LOUD**: The loudness control function is active.
- **Short-cut source icons**: The source changes to the one you have set with a short-cut. For the short-cut setting, refer to **Customize Short-cut source icons on HOME screen (P.16)**.

#### 3 Content list

Displays the track/file/station/channel list.



- Connected Bluetooth device information.

#### 5 Artwork & information

You can select whether to display an artwork and song information or only song information in more detail.

Touching the artwork area switches to the VU meter. (The Disc, USB, iPod, Bluetooth audio sources only)

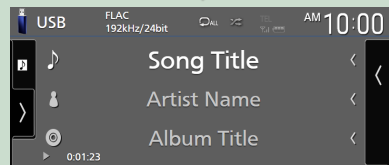
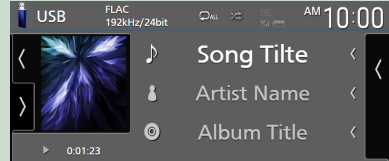

Change the text size of song information smaller when the "Small Audio Text" is set to "ON" in the User Interface screen (P.82).

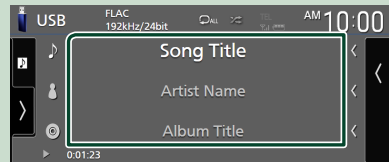
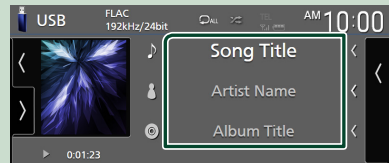

#### 6 Function panel

Touch the left side of the screen to display the function panel. Touch again to close the panel.

#### 7 Operation keys

You can operate the current source with these operation keys. The available functions are different depending on the source type.

## List screen

There are some common function keys in the list screens of most sources.  
See (P.26, 39, 41, 70).

### Display the list screen

#### For Disc media/USB/iPod:

- 1 Touch **Q** or the item listed on the information area in the source control screen.
  - The list screen appears.

#### For Bluetooth audio:

- 1 Touch **Q** .
  - The list screen appears.

You can use following operation keys from this screen.

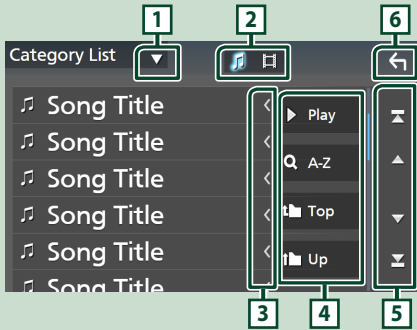

- 1 Displays the list type selection window.

- 2 Displays a music/movie file list.

- 3 **Text scroll**  
Scrolls the displayed text.

- 4 **Play etc.**

Keys with various functions are displayed here.

- **Play**: Plays all tracks in the folder containing the current track.
- **A-Z**: Jumps to the letter you entered (alphabetical search).
- **Top Up**: Moves to the upper hierarchy level.

- 5 **Page scroll**

You can change pages to display more items by touching .

- : Displays the top or bottom page.

- 6 **Return**

Returns to the previous screen.

#### NOTE

- Depending on the current source or mode, some function key may not appear.

# Widget

## Widget

- 1 Press the **HOME** button.
- 2 You can change the widget by flicking left or right on the widget area.



### Widget list

- Multi Widget \*1
- Clock Widget
- Tire Pressure Widget \*2
- Rader Widget \*2
- Climate Widget \*2
- Photo Frame Widget

\*1 Up to 3 pages can be set to the multi widget screen.

\*2 Displayable widgets vary depending on the type of the connected iDataLink (commercially available) and the model of the vehicle.

## Multi Widget

You can place a widget on each of the following areas. Up to 4 widgets can be placed per a multi widget screen.

- 1 Press the **HOME** button.
- 2 Flick the widget area to the left/right to display the multi widget.



1 Widget (L)

2 Widget (M)

3 Widget (S1)

4 Widget (S2)

### Replace the widget

#### ● To move the widget

- 1 Touch and hold the widget.
  - Widget customize mode is activated.
- 2 Drag the widget to the desired position.

#### ● To delete the widget

- 1 Touch and hold the widget.
  - Widget customize mode is activated.
- 2 Touch **×** on the right top corner of the widget.
  - The selected widget is deleted.

● To replace the widget

1 Touch ▼ on the multi widget screen.

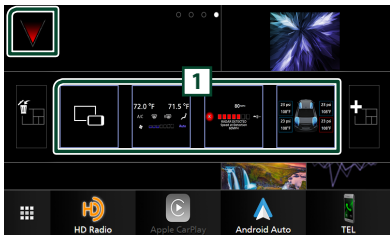

➤ Widget list popup appears.

1 Widget icon

The widgets which can be placed to the multi widget screen are listed.

2 Flick the widget list popup to the left/right to select the widget to replace.

3 Touch and hold the new widget.

➤ Widget customize mode is activated.

4 Drag the widget from the widget list popup to the desired widget area.

You can set up following items.

- Clock Widget
- Compass Widget
- Current source information \*1
- Visualizer Widget
- Mirroring Widget \*2 \*3
- Photo Frame Widget
- Climate Widget \*4
- Radar Widget \*4
- Tire Pressure Widget \*4

\*1 You cannot display the screen of Wireless Mirroring/USB Mirroring on this widget. To display the screen of the source, select the Mirroring Widget.

\*2 This can be selected when using Wireless Mirroring/USB Mirroring.

\*3 You cannot play the video file on the USB/Disc media when using Wireless Mirroring/USB Mirroring.

\*4 This can be selected when a compatible ADS adapter is connected.

**NOTE**

- ▼ and the widget list popup disappear when no operation is done for 5 seconds.
- When the screen is switched from another widget to multi widget screen, ▼ appears again.

■ Add a new multi widget

You can add pages to the multi widget screen.

1 Touch ▼ on the multi widget screen.

➤ Widget list popup appears.



Displays confirmation message to delete the current page from the multi widget screen. For details, see **To delete the multi widget (P.20)**.



Adds a page to the multi widget screen.

2 Touch ■ on the widget list popup.

➤ A new page is added.

**NOTE**

- You can add up to 2 pages to the multi widget screen. If you have already added 2 pages, you cannot select ■.
- The widget list popup is displayed on the new page until you place a widget to.

**To delete the multi widget**

1 Touch ■ on the widget list popup.

➤ Confirmation message appears.

2 Touch **YES**.

➤ Current page is deleted.

**NOTE**

- You cannot delete the first page of the multi widget screen.

## Photo Frame Widget

You can display a slideshow of the image files stored in the USB memory on the Home screen.

### Preparation

- Select "ON" for Photo Frame Widget. See **Widget SETUP (P.21)**.

#### Acceptable Picture files

	Max. Picture size
JPEG (.jpg, .jpeg) *1	5,000 × 5,000
PNG (.png)	1,000 × 1,000
BMP (.bmp)	1,000 × 1,000

- This unit can only play back files which are less than 50 MB.
- The maximum number of files per device is 500.
- Picture files may not be played depending on their condition.

\*1 A progressive format is not supported.

### Photo Frame

- 1 Press the **HOME** button.
- 2 Flick the widget area to the left/right to display the photo frame widget.

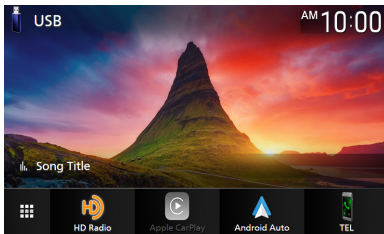

- Scroll the screen to display the hidden part.

## Widget SETUP

Set up the widgets on the Home screen.

- 1 Press the **MENU** button.  
➤ Popup menu appears.
- 2 Touch **SETUP**.  
➤ SETUP screen appears.
- 3 Touch **User Interface**.



- User Interface screen appears.

- 4 Touch **Widget SETUP** in the User Interface screen.
- 5 Set each item as follows.
  - **Photo Frame Widget**  
Determine whether to use the photo frame widget.  
"ON" (Default)/"OFF"
  - **Photo Frame SETUP**  
Make settings related to display of the photo frame widget.
- 6 Touch .

## Widget

### To Photo Frame Setup

Make settings related to display of the photo frame widget.

**1** Touch **Photo Frame SETUP** on the **Widget SETUP** screen.

**2** Set each item as follows.

■ **Sort Order**

Specify a file sorting criterion.

"By Name(Ascending)"/

"By Name(Descending)"/

"By Date(Newest First)"(Default)/

"By Date(Oldest First)"

■ **Slide Show Interval**

Specify the slideshow interval.

"5" to "30" seconds.

Default is "5" seconds.

■ **Photo Frame is** ●●●●●

Display help topics about the photo frame.

**3** Touch  .

# Disc (DDX9907XR / DDX9707S)

## Playing a disc

### Insert a disc

- 1 Press the **▲** button.



- 2 Touch **DISC EJECT**.

➤ The panel opens.

- 3 Insert the disc into the slot.

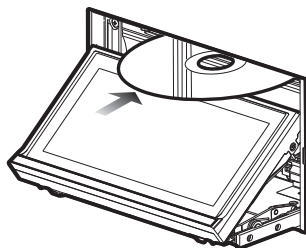

➤ The panel closes automatically.  
The unit loads the disc and playback starts.

### Eject a disc

- 1 Press the **▲** button.

- 2 Touch **DISC EJECT**.

When removing a disc, pull it horizontally.

- 3 Press the **▲** button.

➤ The panel closes.

#### NOTE

- To forcibly eject the disc, press and hold the **▲** button for 2 seconds and then touch **DISC EJECT** after the message is displayed.

## DVD/VCD Basic Operation

Most functions can be controlled from the source control screen and playback screen.

#### NOTE

- Set the remote control mode switch to DVD mode before starting operation for DVD and VCD, see **Switch the operation mode (P.96)**.
- The screen shot below is for DVD. It may be different from the one for VCD.

- 1 When the operation keys are not displayed on the screen, touch **7** area.

#### Control screen

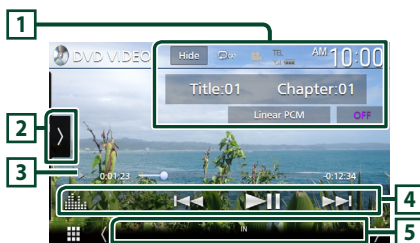

#### Video screen









- 1 **Information display area**

Displays the following information.

- **Title #, Chapter #:** DVD title and chapter number

## Disc











- **Track #/Scene #:** VCD track or scene number. Scene # is displayed only when Playback control (PBC) is on.
- **Linear PCM, etc.:** Audio format
- **OFF/Zoom2 – 4 (DVD)/Zoom2 (VCD):** Displays the zoom ratio. This function can be used from the remote control. **(P.96)**
- **Hide:** Hides the control screen.
- : Repeats the current content. Each time you touch the key, repeat modes are switched in the following sequence;  
**DVD:** Title repeat (  ), Chapter repeat (  ), Repeat off (  )  
**VCD (PBC On):** Does not repeat  
**VCD (PBC Off):** Track repeat (  ), Repeat off (  )

### 2 Function panel

Touch the left side of the screen to display the function panel. Touch again to close the panel.

- : Stops playback. Touching twice will play the disc from the beginning when you play it next time.
-  : Fast-forwards or fast-backward the disc. Each time you touch the key, the speed changes. 2 times, 10 times.
-   (DVD only): Plays in slow motion forward or backward.
- **SETUP** (DVD only): Touch to display the DVD SETUP screen. See **DVD SETUP (P.28)**.
- **MENU CTRL** (DVD only): Touch to display the DVD-VIDEO disc menu control screen. See **DVD Disc Menu Operation (P.27)**.
- **PBC** (VCD only): Touch to turn Playback control (PBC) on or off.
- **Audio** (VCD only): Touch to change audio output channels.
- **Direct Number** (VCD only): Touch to display the Direct Number dialog only when Playback control (PBC) is on. You can directly enter the track number to play when scene is selected.
-  (VCD only): Returns to the previous scene only when Playback control (PBC) is on.





### 3 Play mode indicator/Playing time

- , , , etc.: Current play mode indicator. Meanings of the icons are as follows:  (play),  (fast forward),  (fast backward),  (stop),  (resume stop),  (pause),  (slow playback),  (slow reverse playback).

- For confirmation of current playing position. You can drag the circle left or right to change the playing position.



### 4 Operation keys

-  : Searches for the previous/next content. Touch and hold to fast-forward or fast-backward the disc. (It will be cancelled automatically after about 50 seconds.)
- : Plays or pauses.
- : Displays the Graphic Equalizer screen. **(P.90)**

### 5 Indicator Items

- **IN:** Disc insertion status.  
White: A Disc is inside the unit.  
Orange: Disc player failure.

### VCD

- **1chLL/2chLL:** Identifies the left audio output of channel 1 or 2.
- **1chLR/2chLR:** Identifies the monaural audio output of channel 1 or 2.
- **1chRR/2chRR:** Identifies the right audio output of channel 1 or 2.
- **1chST/2chST:** Identifies the stereo audio output of channel 1 or 2.
- **LL:** Identifies the left audio output.
- **LR:** Identifies the monaural audio output.
- **RR:** Identifies the right audio output.
- **ST:** Identifies the stereo audio output.
- **PBC:** The PBC function is on.
- **VER1:** The VCD version is 1.
- **VER2:** The VCD version is 2.

### 6 Searching area

Touch to search for the next/previous content.

### 7 Key display area

Touch to display the control screen.

### 8 MENU CTRL (DVD only)

Touch to display the DVD-VIDEO disc menu control screen. See **DVD Disc Menu Operation (P.27)**.

#### NOTE

- The control screen disappears when no operation is done for 5 seconds.
- If you use a remote control, you can jump directly to the desired image by entering the chapter number, scene number, etc. **(P.96)**.



## Music CD/Disc media Basic Operation

Most functions can be controlled from the source control screen and playback screen.

### NOTE

- Set the remote controller mode switch to AUD mode before starting operation for Music CD and audio files, see **Switch the operation mode (P.96)**.
- In this manual, "Music CD" means a general CD which includes music tracks.  
"Disc media" means a CD/DVD disc which includes audio or video files.
- The screen shot below is for disc media. It may be different from the one for CD.

### Control screen

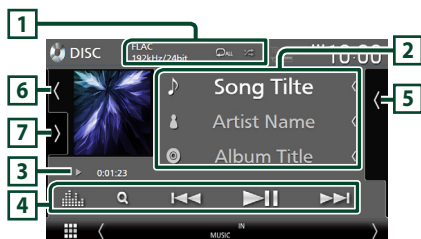

### Open the drawer

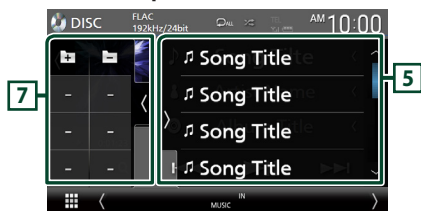

### Close the drawer

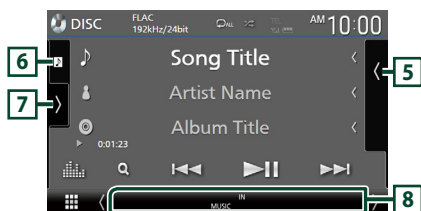

### 1 CODEC/ [Repeat] / [Shuffle]

- When a high-resolution source is played, its format information is displayed. (Disc media only)

- [Repeat] : Repeats the current track/folder. Each time you touch the key, repeat mode switches in the following sequence; Track/File repeat ([Repeat]), Folder repeat ([Folder Repeat]) (Disc media only), Repeat all ([Repeat All])
- [Shuffle] : Randomly plays all tracks in current folder/disc. Each time you touch the key, random mode switches in the following sequence; Track random ([Shuffle All]) (Music CD only), Folder random ([Shuffle Folder]) (Disc media only), Random off ([Shuffle Off])

### 2 Track information

- Displays the information of the current track/file. Only a file name and a folder name are displayed if there is no tag information. (Disc media only)
- Change the text size of the information smaller when the "Small Audio Text" is set to "ON" in the User Interface screen (P.82).

### 3 Play mode indicator/Playing time

- [Play], [Fast Forward], etc.: Current play mode indicator  
Meanings of the icons are as follows: [Play] (play), [Fast Forward] (fast forward), [Fast Backward] (fast backward), [Pause] (pause).
- For confirmation of current playing position. You can drag the circle left or right to change the playing position. (Video file only)



### 4 Operation keys

- [Search] (Disc media only) : Searches files. For details on search operation, see **File search Operation (P.26)**.
- [Previous/Next] : Searches for the previous/next content.  
Touch and hold to fast-forward or fast-backward the disc. (It will be cancelled automatically after about 50 seconds.)
- [Play/Pause] : Plays or pauses.
- [Equalizer] : Displays the Graphic Equalizer screen. (P.90)

### 5 Content list

- Touch the right side of the screen to display the Content list. Touch again to close the list.
- Displays the playing list. When you touch a track/file name on the list, playback will start.

**6 Artwork/VU meter**

- Displays/hides artwork area.
- The jacket of the currently playing file is displayed. (Disc media only)
- Touch to switch between the artwork and VU meter.

**7 Function panel (Disc media only)**

Touch the left side of the screen to display the function panel. Touch again to close the panel.

- : Searches for the previous/next folder.

**8 Indicator Items**

- **IN** : Disc insertion status.  
White: A Disc is inside the unit.  
Orange: Disc player failure.
- **VIDEO** : Identifies the video file.
- **MUSIC** : Identifies the music file.

**Video screen**



**9 File search area (Video file only)**

Touch to search for the next/previous file.

**10 Key display area (Video file only)**

Touch to display the control screen.

**File search Operation (Disc media only)**

You can search for a file according to hierarchy.

**NOTE**

- For operations in the list screen, see **List screen (P.18)**.

**1 Touch Q.**

- Folder List screen appears.

**2 Touch the desired folder.**

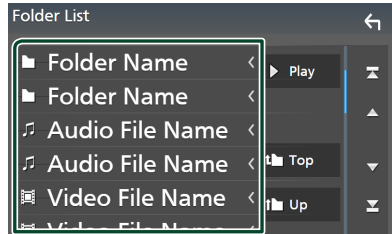

- When you touch a folder its contents are displayed.

**3 Touch the desired item in the content list.**

- Playback starts.

## DVD Disc Menu Operation

You can set up some functions using the DVD-VIDEO disc menu.

### 1 Touch the framed area during playback.



➤ Menu Control screen appears.

### 2 Perform your desired operation as follows.

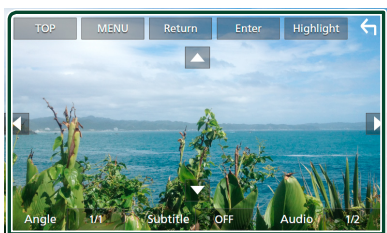

#### ■ To display the top menu

Touch **TOP**.\*

#### ■ To display the menu

Touch **MENU**.\*

#### ■ To display the previous menu

Touch **Return**.\*

#### ■ To enter selected item

Touch **Enter**.

#### ■ To enable direct operation

Touch **Highlight** to enter the highlight control mode (P.27).

#### ■ To move the cursor

Touch ▲, ▼, ◀, ▶.

#### ■ To switch among subtitle languages

Touch **Subtitle**. Each time you touch this key, subtitle languages are switched.

#### ■ To switch among audio languages

Touch **Audio**. Each time you touch this key, audio languages are switched.

#### ■ To switch among picture angles

Touch **Angle**. Each time you touch this key, picture angles are switched.

\*These keys may not function depending on the disc.

## Highlight control

Highlight control lets you control the DVD menu by touching the menu key directly on the screen.

### 1 Touch **Highlight** on the Menu Control screen.

### 2 Touch your desired item on the screen.



#### NOTE

- The highlight control function is cancelled automatically if you do not operate for a predetermined period of time.

## DVD SETUP

You can set up the DVD playback functions.

### 1 Touch the framed area during playback.

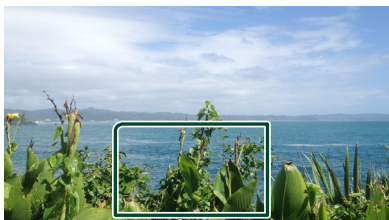

### 2 Touch on the left side of the screen. Touch **SETUP**.



► DVD SETUP screen appears.

### 3 Set each function as follows.

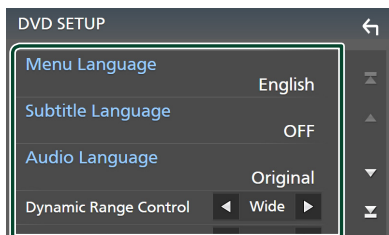

#### ■ **Menu Language/Subtitle Language/Audio Language**

See **Language setup (P.28)**.

#### ■ **Dynamic Range Control**

Sets the dynamic range.

**Wide**: The dynamic range is wide.

**Normal**: The dynamic range is normal.

**Dialog** (Default): Makes the total sound volume larger than the volumes in other modes. This is effective only when the Dolby Digital software is in use.

#### ■ **Screen Ratio**

Sets the screen display mode.

**16:9** (Default): Displays wide pictures.

**4:3 LB**: Displays wide pictures in the Letter Box format (having black stripes at the top and bottom of screen).

**4:3 PS**: Displays wide pictures in the Pan & Scan format (showing pictures cut at the right and left ends).

#### **Language setup**

This setting is for the languages used for the menu, subtitle, and voice.

### 1 Touch the desired item; **Menu Language**, **Subtitle Language**, **Audio Language**.

► Language Set screen appears.

### 2 Select a language.

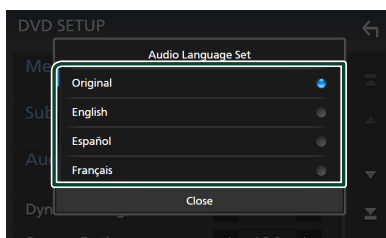

For language codes, refer to **DVD Language Codes (P.115)**.

Touch Close to set the entered language and return to the DVD SETUP screen.

#### **NOTE**

- To set the DVD's original language as the audio language, touch **Original**.

## APPS

### Wireless Mirroring Operation

You can display the same screen of the Android smartphone on the monitor of the unit using the Wireless Mirroring function of the Android smartphone.

#### Preparation

- You can use the Wireless Mirroring function with Android smartphones compatible with this function.
- This function may be called Wireless Display, Screen Mirroring, AllShare Cast, etc., depending on the manufacturer.
- The settings on the Android smartphone differ depending on the device type. For details, refer to the instruction manual supplied with your Android smartphone.
- If your Android smartphone is locked, Mirroring screen may not appear.
- If the Android smartphone is not ready for UIBC, you cannot perform touch operation.

- 1 Press the **HOME** button.
- 2 Touch .
- 3 Touch **Wireless Mirroring** . (P.15)
  - The App screen is displayed.
- 4 Operate your Android smartphone to activate the Wireless Mirroring function, then connect to this unit.
- 5 Select ("DDX\*\*\*\*"/"DMX\*\*\*\*") as the network to use.
  - When the connection is established, then the same screen displayed on the Android smartphone is displayed.

#### NOTE

- Apps is discontinued when the power is turned ON/OFF or you leave the vehicle. To restart Apps, operate the Android smartphone.
- When the Apps source is displayed, you cannot register or reconnect a Bluetooth device. Switch the Apps source to another source, and then operate the Bluetooth device.

### USB Mirroring Operation

With Mirroring for KENWOOD application installed on your smartphone, you can display the screen of your smartphone on the screen of this unit and listen to either the audio of your smartphone or current source of this unit. You may access your smartphone from this unit.

You can use the USB Mirroring function with your smartphone compatible with this function.

#### Compatible devices

- Android smartphone
  - Bluetooth support
  - Android version 5.0 or later
  - Linux Kernel version 3.5 or later
- iPhone
  - Bluetooth support
  - iOS version 11 or later

#### Preparation

- Install the latest version of the Mirroring for KENWOOD application and activate the application on your smartphone.
    - Android smartphone** : Search for "Mirroring for KENWOOD" in Google Play to find and install the most recent version.
    - iPhone** : Search for "Mirroring for KENWOOD" in Apple App Store to find and install the most recent version.
- Mirroring for KENWOOD application is a free application. You can check "how to" tutorial in Mirroring for KENWOOD application.

#### Connect the device

Screen is mirrored through USB (Black) terminal connection while audio is shared via Bluetooth connection between this unit and your smartphone.

**For Android smartphones:**

**1** Pair your Android smartphone with this unit via Bluetooth. See *Register the Bluetooth device (P.65)*.

Select A2DP/SPP **Audio/App**.

**2** Press the **HOME** button.

**3** Touch .

**4** Touch **USB Mirroring**. (P.15)

**5** Connect your Android smartphone via the USB (Black) terminal. (P.107)

When you use Mirroring for KENWOOD application for the first time, the terms of service are displayed. It is necessary to agree to the terms of service to use this function.

**For iPhone:**

**1** Pair your iPhone with this unit via Bluetooth. See *Register the Bluetooth device (P.65)*.

Select A2DP/SPP **Audio/App**.

**2** Touch "Mirroring for KENWOOD" and start broadcast.

**3** Press the **HOME** button.

**4** Touch .

**5** Touch **USB Mirroring**. (P.15)

**6** Connect your iPhone using KCA-iP103 via the USB (Black) terminal. (P.107)

**7** Operate your iPhone to complete followings.





- Launch "Settings", then touch "Control Center" and then "Customize Controls".
- Touch "Screen Recording" and add to "INCLUDE" list.
- Launch "Control Center" of your iPhone, then touch and hold Screen Recording icon.

**NOTE**

- USB (Gray) terminal does not support USB Mirroring.
- You cannot use the Bluetooth and iPod sources at the same time with Mirroring for KENWOOD application.
- OSD clock is not shown on the mirroring screen of this unit regardless of the setting made for **OSD Clock (P.84)**.
- Depending on the connected Android smartphone, you may need to enable virtual keyboard setting on your smartphone to display software keyboard on the screen of this unit and on your smartphone.
- Mirroring for KENWOOD application is discontinued by the following operations if you use the application with an iPhone:
  - Receiving an incoming call
  - iPhone's screen recording function is stopped
  - iPhone screen is turned off
 To resume the mirroring operation, disconnect the iPhone from the USB Audio cable, and try connecting it again.
- The audio may be of poor quality, interrupted or skipped, depending on several conditions such as network condition, the application and etc.
- If you perform pairing with another device during mirroring, mirroring (audio and/or video) will be disturbed or paused.
- Some applications may not support audio sharing.
- Some operations may not work depending on the compatibility between this unit, Mirroring for KENWOOD application and your smartphone.

## Operation keys on the mirroring screen

On the USB mirroring screen, the following virtual hard keys are available. The keys are hidden when no operation is done for about 5 seconds. You can display back them anytime by touching the screen.

- : Changes the virtual hard keys position shown on the screen of this unit.
- : Returns to home page.
- : Closes the virtual hard keys.
- : Shows the recent applications (Android only).
- : Returns to the previous page (Android only).

**NOTE**

- These keys differ depending on the connected device and may differ from the function operated from the device.
- These keys can be displayed even if there is no hard key on the connected device.

## Disconnect mirroring

You can disconnect mirroring by disconnecting your smartphone from the USB (Black) terminal from the rear panel.

**NOTE**

- Once you disconnect from mirroring operations, stop broadcast on iPhone's screen recording function. Otherwise "iPod" source and "Bluetooth" source may not work correctly.

## Apple CarPlay Operation

Apple CarPlay is a smarter, safer way to use your iPhone in the car. Apple CarPlay takes the things you want to do with iPhone while driving and displays them on the screen of the product. You can get directions, make calls, send and receive messages, and listen to the music from iPhone while driving. You can also use Siri voice control to make it easier to operate iPhone.

For details about Apple CarPlay, visit <https://www.apple.com/ios/carplay/>.

### Compatible iPhone devices

You can use Apple CarPlay with the following iPhone models.

- iPhone XS Max
- iPhone XS
- iPhone XR
- iPhone X
- iPhone 8 Plus
- iPhone 8
- iPhone 7 Plus
- iPhone 7
- iPhone SE
- iPhone 6s Plus
- iPhone 6s

## Connecting an iPhone

### Preparation

- To register an iPhone by the connection via the USB (Black) terminal
  - Connect an iPhone via the USB (Black) terminal and operate the iPhone according to the confirmation messages displayed on the iPhone. The iPhone is registered in **Apple CarPlay Device List**. Removing the iPhone from the USB (Black) terminal and selecting the registered iPhone from **Apple CarPlay Device List**, the iPhone will be connected wirelessly.
- To register an iPhone by the connection via Bluetooth
  - Touching  on the **Apple CarPlay Device List** screen (P.32), displays Bluetooth pairing waiting dialog. Referring to **Register the Bluetooth device (P.65)** and registering the iPhone, the iPhone will be connected wirelessly.

**Wired connection**

**1** Connect your iPhone using KCA-iP103 via the USB (Black) terminal. (P.107)

When an iPhone compatible with Apple CarPlay is connected to the USB (Black) terminal, the Bluetooth Hands-Free phone currently connected is disconnected. If the Bluetooth Hands-Free phone is being used, disconnection will occur after ending the call.

**2** Unlock your iPhone.

**Wireless connection**

You can select the iPhone registered as the Bluetooth device from **Apple CarPlay Device List** and use it as the Apple CarPlay device.

**1** Press the **HOME** button.

**2** Touch .

**3** Touch **Apple CarPlay**. (P.15)

**NOTE**

- Turn on the Bluetooth function and Wi-Fi function of an iPhone.
- If two or more iPhones have been registered, select the iPhone to be used as the **Apple CarPlay** source. (P.32)
- You can also select the iPhone registered in **Apple CarPlay Device List** (P.32) even when the **Apple CarPlay** icon is not activated on the source selection screen.
- It is necessary to connect the GPS antenna and the speed pulse input in order to use a wireless Apple CarPlay.
- When the Wi-Fi connection becomes unavailable, the HOME screen is displayed.
- You cannot use Apple CarPlay if the iPhone's screen recording function is enabled.

**To switch the Current Screen to the Apple CarPlay Screen When Connecting Your iPhone**

- Touch **Apple CarPlay** icon on the source selection screen. (P.15)
- Touch the following connection message if the message appears.

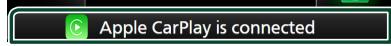

**NOTE**

- The connection message appears when;
  - The iPhone you used previously is connected again.
  - The screen other than HOME and the source selection screen is displayed.
- The connection message is displayed for about 5 seconds.

**Select an Apple CarPlay device**

If two or more iPhones compatible with Apple CarPlay have been registered, select the iPhone to be used as the Apple CarPlay source.

**1** Press the **MENU** button.

➤ Popup menu appears.

**2** Touch **SETUP**.

➤ SETUP screen appears.

**3** Touch **AV**.

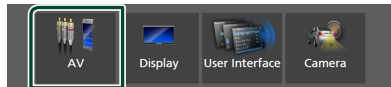



**4** Touch **Apple CarPlay Device List**.

**5** Select a device.

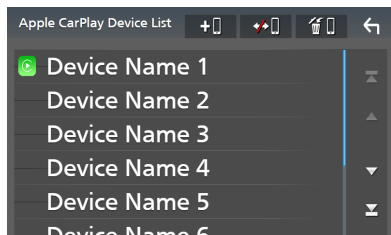
The Apple CarPlay device connected via the USB and the registered Apple CarPlay devices ready for wireless connection are displayed.





-  : Displays a Bluetooth pairing waiting dialog. For details, see **Register the Bluetooth device (P.65)**.
-  : Displays confirmation message to disconnect the device.
-  : Displays Device Remove screen. **(P.33)**

**To delete the registered Apple CarPlay device**

1 Touch .

2 Touch the device name to check.

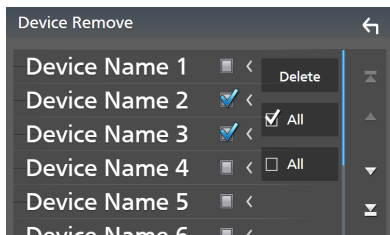

■  **ALL**

Selects all Apple CarPlay devices.

■  **ALL**

Clears all check marks.

3 Touch **Delete**.

➤ Confirmation message appears.

4 Touch **Yes**.

➤ All the selected device(s) is deleted.

**NOTE**

- This operation also deletes the same device(s) from the Bluetooth device list screen. **(P.67)**

**Operation keys and available Apps on the home screen of Apple CarPlay**

You can use the Apps of the connected iPhone. The items displayed and the language used on the screen differ among the connected devices.

To enter the Apple CarPlay mode, touch **Apple CarPlay** icon on the source selection screen. **(P.15)**

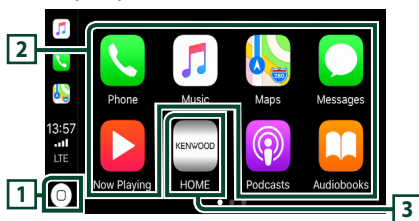

1 \*

- Displays the home screen of Apple CarPlay.
- Touch and hold to activate Siri.

2 **Application keys**

Starts the application.

3 **HOME**

Exits the Apple CarPlay screen and displays the Home screen.

\* The icon design may change depending on the iOS version.

**To exit the Apple CarPlay screen**

1 Press the **HOME** button.

## Use Siri

You can activate Siri.

- 1 Press the  button for 1 second.

DDX9907XR / DDX9707S

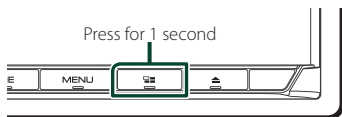

DMX957XR / DMX907S / DMX9707S

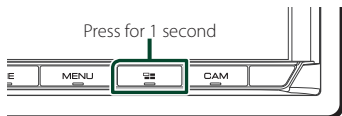

- 2 Talk to Siri.

### To deactivate

- 1 Press the  button.

## Switch to the Apple CarPlay screen while listening to another source

- 1 Press the  button.

DDX9907XR / DDX9707S

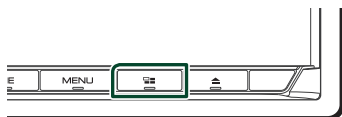

DMX957XR / DMX907S / DMX9707S



### NOTE

- When listening to another source with the Apple CarPlay screen displayed, playing music in the Apple CarPlay mode will switch the current source to the Apple CarPlay source.

## Android Auto™ Operation

Android Auto enables you to use the functions of your Android smartphone convenient for driving. You can easily access route guidance, make calls, listen to music, and access convenient functions on the Android smartphone while driving.

For details about Android Auto, visit <https://www.android.com/auto/> and <https://support.google.com/androidauto>.

### Compatible Android devices

You can use Android Auto with Android devices of Android version 5.0 or later.

For Wi-Fi connection, Android 8.0 or later.

### NOTE

- Android Auto may not be available on all devices and may not be available in all countries or regions.

### ● About the placement of smartphone

Install the smartphone connected as Android Auto device in the place where it can receive the GPS signals.

When using Google Assistant, install the smartphone in the place where the smartphone easily catch a voice by the microphone.

### NOTE

- Do not put the smartphone in a spot exposed to direct sunlight or near an air blowing out port of an air conditioner. The placement of the smartphone in such places can lead to malfunction or damage of your smartphone.
- Do not leave the smartphone in the vehicle.

## Connect Android smartphone

### Wired connection

#### 1 Connect an Android smartphone via the USB terminal. (P.107)

To use the hands-free function, connect the Android smartphone via Bluetooth.

When an Android smartphone compatible with Android Auto is connected to the USB terminal, the device is connected via Bluetooth automatically, and the Bluetooth Hands-Free phone currently connected is disconnected.

#### 2 Unlock your Android smartphone.

#### 3 Press the **HOME** button.

#### 4 Touch .

#### 5 Touch **Android Auto**. (P.15)

### Wireless connection

When the Android smartphone is ready for wireless connection, connecting it via the USB registers Bluetooth and Wi-Fi automatically. Thus, the registered Android smartphone will be able to be connected wirelessly to be used as an Android Auto source.

#### 1 Press the **HOME** button.

#### 2 Touch .

#### 3 Touch **Android Auto**. (P.15)

#### NOTE

- Turn on the Bluetooth function and Wi-Fi function of Android smartphone.
- If two or more Android smartphones have been registered, select the Android smartphone to be used as the Android Auto source. (P.35)
- To change the password for wireless connection manually, refer to **Reset Android Auto Wireless Connection (P.86)**.
- When the Wi-Fi connection becomes unavailable, the HOME screen is displayed.

## Select an Android smartphone

If two or more Android smartphones have been registered, select the Android smartphone to be used as the Android Auto source.

#### 1 Press the **HOME** button.

#### 2 Touch .

#### 3 Touch **Android Auto**. (P.15)

#### 4 Press the **MENU** button.

#### 5 Touch .

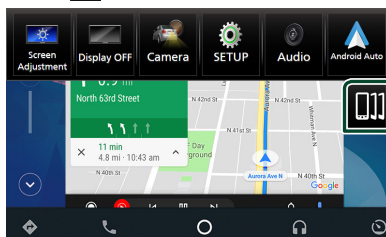

#### 6 Select an Android smartphone.

The registered Android smartphones ready for wireless connection and the Android smartphone connected via the USB are displayed.

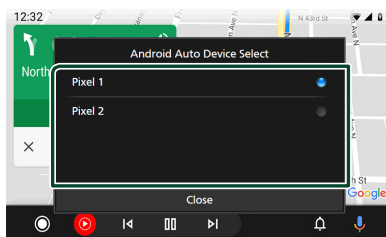

## Operation keys and available Apps on the Android Auto screen

You can perform the operations of the Apps of the connected Android smartphone.

The items displayed on the screen differ among the connected Android devices.

To enter the Android Auto mode, touch the **Android Auto** icon on the source selection screen. (P.15)

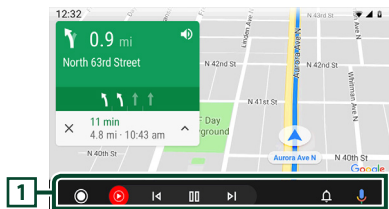

### 1 Application/information keys

Starts the application or displays information.

### To exit the Android Auto screen

1 Press the **HOME** button.

## Using voice control

1 Press the button for 1 second.

DDX9907XR / DDX9707S

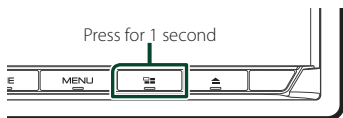

DMX957XR / DMX907S / DMX9707S

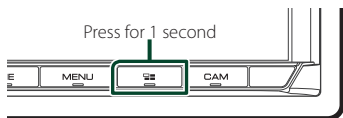

2 Start speaking.

### NOTE

- When you press and hold the button while inputting voice, you can start over from the beginning.

### To cancel

1 Press the button.

## Switch to the Android Auto screen while listening to another source

1 Press the button.

DDX9907XR / DDX9707S



DMX957XR / DMX907S / DMX9707S



### NOTE

- When listening to another source with the Android Auto screen displayed, playing music in the Android Auto mode will switch the current source to the Android Auto source.

# USB

## Connecting a USB device

- 1 Connect the USB device with the USB cable. (P.106)

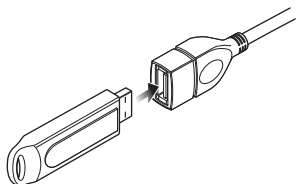

- 2 Press the **HOME** button.
- 3 Touch .
- 4 Touch **USB**. (P.15)

### Disconnect the USB device

- 1 Press the **HOME** button.
- 2 Touch a source other than **USB**.
- 3 Detach the USB device.

### Usable USB device

You can use a mass-storage-class USB device with this unit.

The word "USB device" appearing in this manual indicates a flash memory device.

#### ● About the file system

The file system should be the one of the following.

- FAT16
- FAT32
- exFAT
- NTFS

#### NOTE

- Install the USB device in the place where it will not affect safe driving.
- You cannot connect a USB device via a USB hub and Multi Card Reader.
- Take backups of the audio files used with this unit. The files can be erased depending on the operating conditions of the USB device. We shall have no compensation for any damage arising from any erased data.

## USB Basic Operation

Most functions can be controlled from the source control screen and playback screen.

#### NOTE

- Set the remote controller mode switch to AUD mode before starting operation, see **Switch the operation mode (P.96)**.

### Control screen

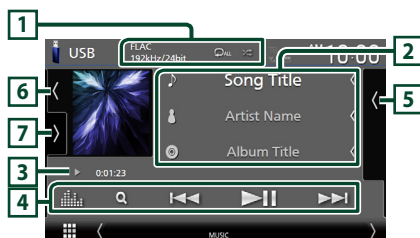



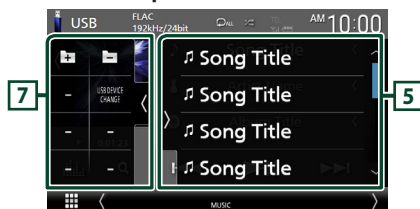

### Open the drawer

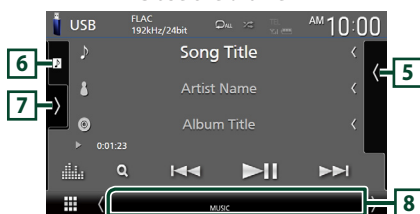



### Close the drawer



### 1 CODEC/ / /

- When a high-resolution source is played, its format information is displayed.
- : Repeats the current track/folder. Each time you touch the key, repeat modes are switched in the following sequence: File repeat () , Folder repeat () , Repeat all ()



## USB

- : Randomly plays all tracks in the current folder. Each time you touch the key, random modes are switched in the following sequence: File random () , Random off ()

### 2 Track information





- Displays the information on the current file. Only a file name and a folder name are displayed if there is no tag information.
- Change the text size of the information smaller when the "Small Audio Text" is set to "ON" in the User Interface screen (P.82).

### 3 Play mode indicator/Playing time

- , , etc.: Current play mode indicator. Meanings of individual icons are as follows:
  - ▶ (play), ▶▶ (fast forward), ◀◀ (fast backward), || (pause).
- For confirmation of current playing position. You can drag the circle left or right to change the playing position. (Video file only)



### 4 Operation keys

- : Searches track/file. For details on search operation, see **Search Operation (P.39)**.
-  : Searches the previous/next track/file. Touch and hold to fast forward or fast backward. (It will be cancelled automatically after about 50 seconds.)
- : Plays or pauses.
- : Displays the Graphic Equalizer screen. (P.90)

### 5 Content list



- Touch the right side of the screen to display the Content list. Touch again to close the list.
- Displays the playing list. When you touch a track/file name on the list, playback will start.

### 6 Artwork/VU meter

- Displays/hides artwork area.
- The jacket of the currently playing file is displayed.
- Touch to switch between the artwork and VU meter.

### 7 Function panel

Touch the left side of the screen to display the function panel. Touch again to close the panel.

-  : Searches for the previous/next folder.

### 8 USB DEVICE CHANGE:

Switches to another USB device when two USB devices are connected.

### 8 Indicator Items

- **VIDEO**: Identifies the video file.
- **MUSIC**: Identifies the music file.

#### Video screen



### 9 File search area (Video file only)

Touch to search for the next/previous file.

### 10 Key display area (Video file only)

Touch to display the control screen.

## Search Operation

You can search music or video files by the following operations.

1 Touch **Q**.

2 Touch **▼**.



3 Select a list type.

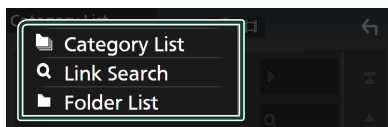



### NOTE

• For operations on the list screen, see *List screen (P.18)*.

## Category search

You can search for a file by selecting a category.

1 Touch **Category List**.

2 Select whether you search audio files  or video files .

3 Touch the desired category.

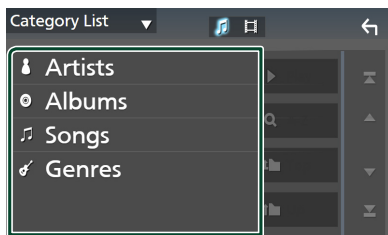

► The list corresponding to your selection appears.

4 Touch to select the desired item in the list. Repeat this step until you find the desired file.

## Link search

You can search for a file of the same artist/album/genre as that in the current track.

1 Touch **Link Search**.

2 Touch the desired tag type. You can select from artists, albums and genres.

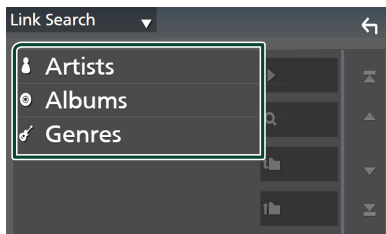

► The list corresponding to your selection appears.

3 Touch the desired item in the content list.

## Folder search

You can search for a file according to hierarchy.

1 Touch **Folder List**.

2 Touch the desired folder.

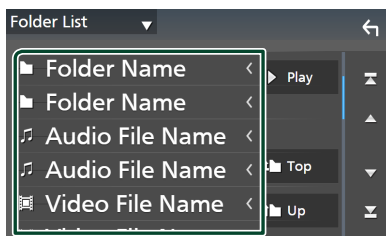

When you touch a folder its contents are displayed.

3 Touch to select your desired item in the list. Repeat this step until you find the desired file.

# iPod/iPhone

## Preparation

### Connectable iPod/iPhone

The following models can be connected to this unit.

Made for

- iPhone XS Max
- iPhone XS
- iPhone XR
- iPhone X
- iPhone 8 Plus
- iPhone 8
- iPhone 7 Plus
- iPhone 7
- iPhone SE
- iPhone 6s Plus
- iPhone 6s
- iPod touch (6th generation)

### NOTE

- Latest compatible list of iPod/iPhone. For details, see [www.kenwood.com/cs/ce/ipod/](http://www.kenwood.com/cs/ce/ipod/).
- By connecting your iPod/iPhone to this unit with the iPod connection cable KCA-iP103 (optional accessory), you can supply power to your iPod/iPhone as well as charge it while playing music. Note that the power of this unit must be held on.
- If you restart playback after connecting the iPod, the music that has been played by the iPod is played first.

### Connect iPod/iPhone

#### Wired connection

##### Preparation

- Connect an iPod/iPhone with the KCA-iP103 (optional accessory) while Apple CarPlay is not connected.
- With an iPhone compatible with Apple CarPlay, turn off Apple CarPlay by operating the iPhone at functional setup before connecting iPhone. For details of the setup method, contact the manufacturer of the terminal.
- Plug the iPod/iPhone into the gray USB terminal with the KCA-iP103 (optional accessory).
- Only one iPod/iPhone can be connected.

**1** Connect the iPod/iPhone using the KCA-iP103. (P.107)

**2** Press the **HOME** button.

**3** Touch .

**4** Touch **iPod**. (P.15)

● **To disconnect the iPod/iPhone connected with the cable:**

**1** Detach the iPod/iPhone.

#### Bluetooth connection

Pair the iPhone through Bluetooth.

##### Preparation

- To connect an iPhone via Bluetooth, register it as a Bluetooth device and do the profile setting for the connection beforehand. See **Register the Bluetooth device (P.65)** and **Connect the Bluetooth device (P.66)**.
- Connect an iPhone via Bluetooth while Apple CarPlay and an iPod/iPhone are not connected via USB.
- With an iPhone compatible with Apple CarPlay, turn off Apple CarPlay by operating the iPhone at functional setup before connecting iPhone. For details of the setup method, contact the manufacturer of the terminal.

## iPod/iPhone Basic Operation

### NOTE

- Set the remote controller mode switch to AUD mode before starting operation, see **Switch the operation mode (P.96)**.

#### Control screen

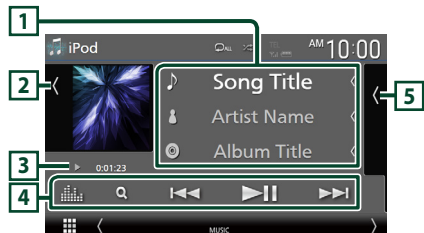

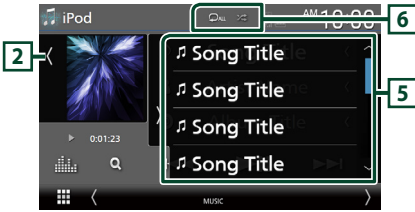
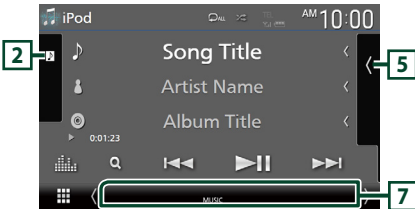

**Open the drawer****Close the drawer****1 Track information**

- Displays the information on the current file.
- Touch to display the category list screen. See **Category search (P.42)**.
- Change the text size of the information smaller when the "Small Audio Text" is set to "ON" in the User Interface screen **(P.82)**.

**2 Artwork/VU meter**

- Displays/hides artwork area.
- The jacket of the currently being played file is displayed.
- Touch to switch between the artwork and VU meter.

**3 Play mode indicator/Playing time**

- ▶, ▶▶, etc.: Current play mode indicator  
Meanings of individual icons are as follows:  
▶ (play), ▶▶ (fast forward), ◀◀ (fast backward), || (pause).

**4 Operation keys**

- 🔍 : Searches for a track/file. For details on search operation, see **Search Operation (P.41)**.
- ◀◀ ▶▶ : Searches for the previous/next track/file.  
Touch and hold to fast forward or fast backward. (It will be cancelled automatically after about 50 seconds.)
- ▶|| : Plays or pauses.
- 📊 : Displays the Graphic Equalizer screen. **(P.90)**

**5 Content list**

- Touch the right side of the screen to display the Content list. Touch again to close the list.
- Displays the playing list. When you touch a track/file name on the list, playback will start.

**NOTE**

- Content list cannot be used unless Category List is selected. To select a file, see **Category search (P.42)**.

**6**

- 🔄 : Repeats the current track/album. Each time you touch the key, repeat modes are switched in the following sequence:  
Song repeat (🔄), All songs repeat (🔄ALL), Repeat off (🔄)
- 🎲 : Randomly plays all tracks in the current album. Each time you touch the key, random modes are switched in the following sequence:  
Song random (🎲), Random off (🎲)

**7 Indicator Items**

- **MUSIC**: Identifies the music file.

**Search Operation**

You can search music files by the following operations.

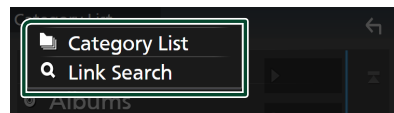
**1 Touch 🔍.****2 Touch ▼.****3 Select a list type.****NOTE**

- For operations on the list screen, see **List screen (P.18)**.

## Category search

You can search for a file by selecting a category.

- 1 Touch **Category List**.
- 2 Touch the desired category.

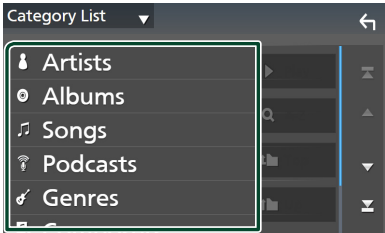

➤ The list corresponding to your selection appears.

- 3 Touch to select the desired item in the list. Repeat this step until you find the desired file.

## Link search (Audio file only)

You can search for a file of the same artist/album/genre/composer as that in the current track.

- 1 Touch **Link Search**.
- 2 Touch the desired tag type. You can select from artists, albums, genres and composers.

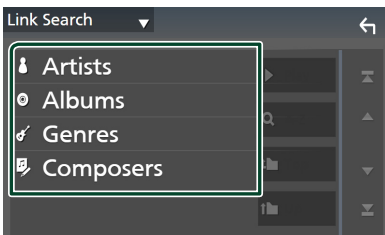

➤ The list corresponding to your selection appears.

- 3 Touch the desired item in the content list.

# Radio (DDX9707S / DMX9707S)

## Radio Basic Operation

Most functions can be controlled from the source control screen.

To listen to the Radio source, touch **Radio** icon on the source selection screen. (P.15)

### NOTE

- Set the remote control mode switch to **AUD** mode before starting operation, see **Switch the operation mode (P.96)**.

### Control screen

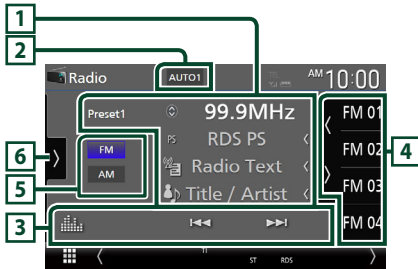

### Open the drawer

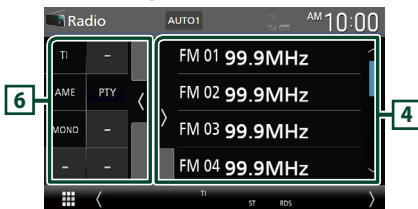

### Close the drawer

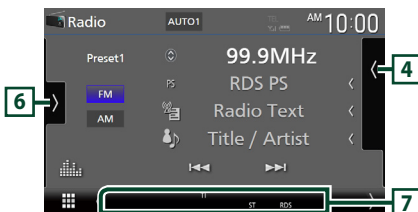

### 1 Information display

- Displays the information on the current station:
  - Frequency
  - Touching allows you to switch between Content A and Content B.
  - Content A: PS name, Radio Text, Title & Artist
  - Content B: PTY Genre, Radio Text plus
  - Preset#**: Preset number
- Change the text size of the information smaller when the "Small Audio Text" is set to "ON" in the User Interface screen (P.82).

### 2 Seek mode

Touch to switch seek mode in the following sequence: **AUTO1**, **AUTO2**, **MANUAL**.

- AUTO1**: Tunes in a station with good reception automatically.
- AUTO2**: Tunes in the memorized stations one after another.
- MANUAL**: Switches to the next frequency manually.

### 3 Operation keys

- : Tunes in a station. The method of switching frequencies can be changed (see **2** Seek mode).
- : Displays the Graphic Equalizer screen. (P.90)

### 4 Preset list

- Touching allows you to change the display size.
- Recalls the memorized station.
- When touched for 2 seconds, stores the currently being received station in the memory.

### 5 Band keys

Switches bands (between FM and AM).

### 6 Function panel

Touch the left side of the screen to display the function panel. Touch again to close the panel.

- TI** (FM only): Selects the traffic information mode. For details, see **Traffic Information (P.45)**.
- AME**: Presets stations automatically. For details, see **Auto memory (P.44)**.

## Radio

- **PTY** (FM only) : Searches for a program by program type. For details, see **Search by program type (P.45)**.
- **MONO** (FM only) : Selects the Monaural reception mode.

### 7 Indicator Items

- **ST** : A stereo broadcast is being received.
- **MONO** : The forced monaural function is active.
- **TI** : Indicates the reception state of traffic information.
  - White: TP is being received.
  - Orange: TP is not being received.

## Memory Operation

### Auto memory

You can store stations with good reception in the memory automatically.

#### 1 Touch desired band key.

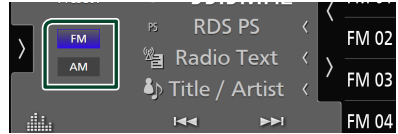

#### 2 Touch **>** on the left side of the screen. Touch **AME**.

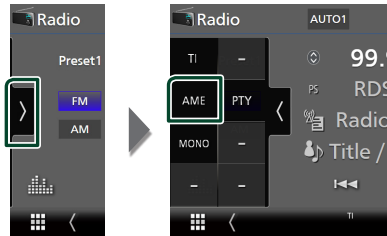

#### 3 Touch **Yes**.

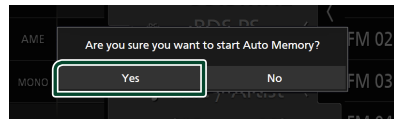

> Auto memory starts.

### Manual memory

You can store the currently being received station in the memory.

#### 1 Select the station you wish to store in the memory.

#### 2 Touch **FM#** (#:1-15) or **AM#** (#:1-5) in which you want to store the station for 2 seconds until a beep sounds.

## Selecting Operation

### Preset select

You can list and select memorized stations.

- 1 Touch  on the right side of the screen. Select a station from the list.

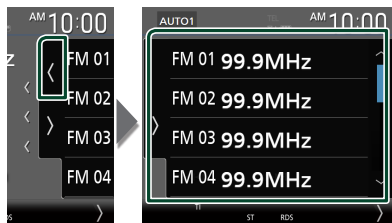

### Search by program type (FM only)

You can tune in the station broadcasting the specified type of program when listening to FM.

- 1 Touch  on the left side of the screen. Touch **PTY**.

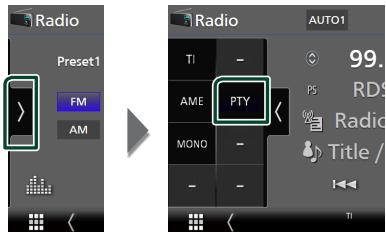

► TUNER PTY Mode screen appears.

- 2 Select a program type from the list.
- 3 Touch **Search**.

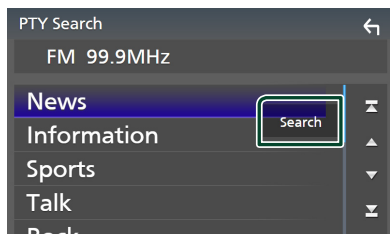

You can search for the station broadcasting the selected type of program.

## Traffic Information (FM only)

You can listen to and watch traffic information automatically when a traffic bulletin starts. However, this feature requires a Radio Broadcast Data System that includes TI information.

- 1 Touch  on the left side of the screen. Touch **TI**.

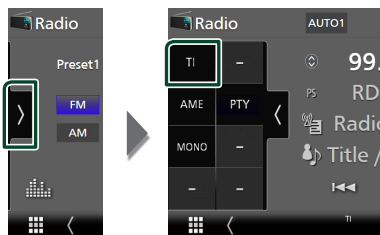

► Traffic information mode is set.

### When the traffic bulletin starts

The Traffic Information screen appears automatically.

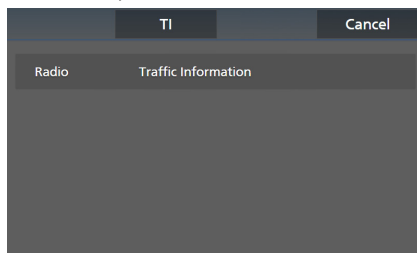

#### NOTE

- It is necessary to turn on the Traffic Information function in order to allow the Traffic Information screen to appear automatically.
- The volume setting made during reception of traffic information is automatically memorized. When the traffic information is received next time, this unit recalls the volume setting automatically.
- To cancel Traffic Information: Touch **Cancel**.

# HD Radio™ Tuner (DDX9907XR / DMX957XR / DMX907S)

## HD Radio Tuner Basic Operation

Most functions can be controlled from the source control screen.

To listen to the HD Radio source, touch **HD Radio** icon on the source selection screen. (P.15)

### NOTE

- Set the remote control mode switch to AUD mode before starting operation, see **Switch the operation mode (P.96)**.
- HD Radio broadcasting is for North American sales area only.

Control screen

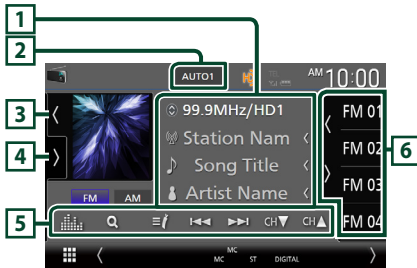

Open the drawer



Close the drawer

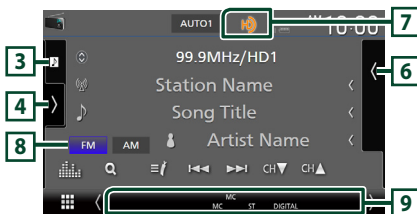

### 1 Information display

- Displays the information on the current station: Frequency and Channel  
Touching  allows you to switch between Content A, Content B and Content C.  
Content A: Station name, Song Title, Artist Name  
Content B: Station Message, Radio Text  
Content C: PTY Genre, Album Name
- Change the text size of the information smaller when the "Small Audio Text" is set to "ON" in the User Interface screen (P.82).

### 2 Seek mode

Touch to switch seek mode in the following sequence: **AUTO1** , **AUTO2** , **MANUAL** .

- **AUTO1** :Tunes in a station with good reception automatically.
- **AUTO2** :Tunes in the memorized stations one after another.
- **MANUAL** : Switches to the next frequency manually.

### 3 Picture

- Displays/hides picture area.
- The picture data or station Logo data is displayed if available from current content.

### 4 Function panel

Touch the left side of the screen to display the function panel. Touch again to close the panel.

- **10key Direct** : Display the direct station/channel search screen. For details, see **Direct search (P.49)**.
- **AME** : Presets stations automatically. For details, see **Auto memory (P.48)**.
- **RCV** : Change the HD Radio reception mode. For details, see **Receive Mode (P.48)**.
- **PTY** (FM only): Searches for a program by program type. For details, see **Search by program type (P.49)**.
-  : Stores the information about the song being received. See **Bookmark (P.50)**.
- **Emergency Alerts** : Turn on or off the alert message. See **Alert Message (P.51)**.
- **Alert Message Log** : Displays the alert message received. See **Alert Message (P.51)**.

## 5 Operation keys

- **◀◀ ▶▶** : Tunes in a station. The method of switching frequencies can be changed (see **2** Seek mode).
- **CH▼ CH▲** : Selects a channel.
- **🔍** : Display the Channel List screen. See **Channel search (P.49)**.
- **📌** : Display a list of registered bookmarks. See **Bookmark list (P.50)**.
- **📊** : Displays the Graphic Equalizer screen. **(P.90)**

## 6 Preset list

- Touching **📌/📌** allows you to change the display size.
- Recalls the memorized station or channel.
- When touched for 2 seconds, stores the currently being received station or channel in the memory.

## 7 Indicator display

While receiving an HD Radio station, it lights with orange when the audio is digital and lights with gray when it is analog. While receiving an analog station, it is off.

## 8 Band keys

Switches bands (between FM and AM).

## 9 Indicator Items

- **MC**: A multicast digital broadcast is being received.
- **ANALOG**: An analog broadcast is being received.
- **DIGITAL**: A digital broadcast is being received.
- **ST**: A stereo broadcast is being received.
- **EA**:
  - White: Emergency Alert is on.
  - No light: Emergency Alert is off.
  - Orange: Interrupting or in snooze/ignore state.

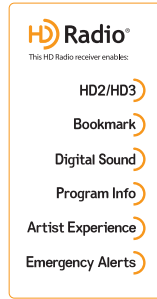

## HD2/HD3

- Adjacent to traditional main stations are HD2/HD3 Channels, providing new original programming on the FM dial

## Bookmark

- A music & product discovery feature that enables users to store information about content on the radio, and can deliver interactive information via QR codes

## Digital Sound

- Crystal clear, CD-like digital audio quality to consumers; eliminates background noise

## Program Info

- Provides song name, artist, station ID, and other relevant data to enrich the listening experience

## Artist Experience

- Visual images, such as album art of over-the-air broadcasts from HD Radio stations

## Emergency Alerts

- Delivers critical and life-saving messages to the public during emergency situations

## Receive Mode

You can set the radio broadcasts receive mode.

- 1 Touch **>** on the left side of the screen. Touch **RCV**.

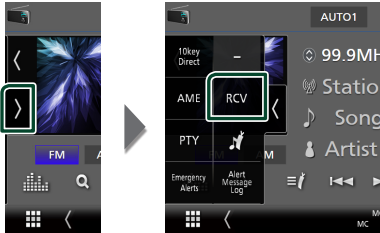

- 2 Select a receive mode.

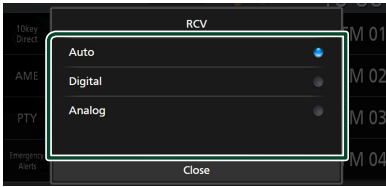

### ■ Auto

Switch between digital and analog audio automatically.

### ■ Digital

Select this to tune to digital audio only.

### ■ Analog

Select this to tune to analog audio only.

## Memory Operation

### ■ Auto memory

You can store stations with good reception in the memory automatically.

- 1 Touch desired band key.

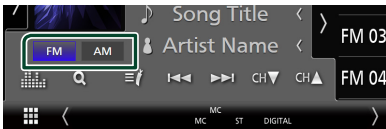

- 2 Touch **>** on the left side of the screen. Touch **AME**.

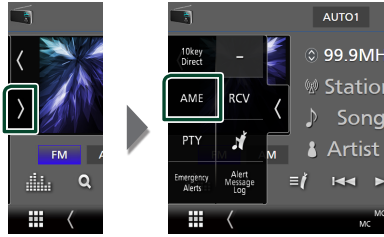

- 3 Touch **Yes**.

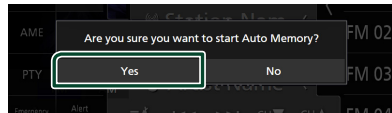

> Auto memory starts.

### ■ Manual memory

You can store the currently being received station or channel in the memory.

- 1 Select the station or channel you wish to store in the memory.
- 2 Touch **FM#** (#:1-15) or **AM#** (#:1-5) in which you want to store the station or channel for 2 seconds until a beep sounds.

## Selecting Operation

### ■ Preset select

You can list and select memorized stations or channels.

- 1 Touch **<** on the right side of the screen. Select a station or channel from the list.

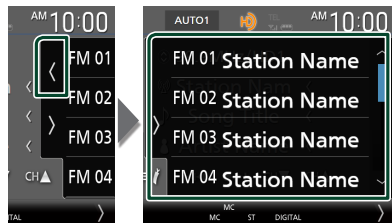



## Direct search

You can tune in by entering the desired frequency or channel number.

- 1 Touch **>** on the left side of the screen. Touch **10key Direct**.

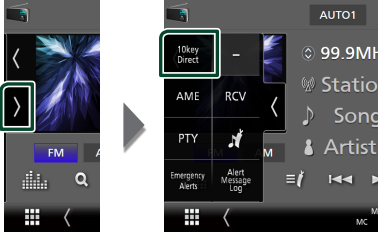

- 2 Select the search method.

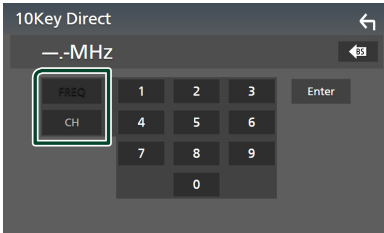

- 3 Enter the frequency or channel number.
- 4 Touch **Enter**.

### NOTE

- To clear the number you entered, touch **BS**.

## Channel search

You can specify the desired channel.

- 1 Touch **Q**.

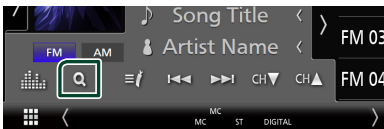

- 2 Select the desired content from the list.

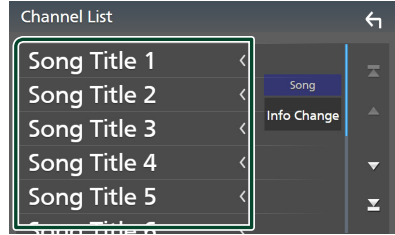

### NOTE

- Touch **Info Change** in the channel list. Select the sequence of the list (Song title, artist name, album name).

## Search by program type (FM only)

You can tune in the station broadcasting the specified type of program when listening to FM.

- 1 Touch **>** on the left side of the screen. Touch **PTY**.

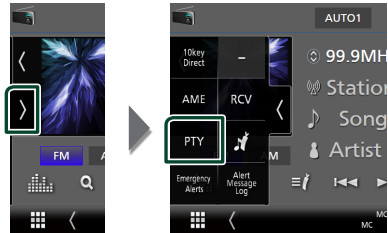

▶ TUNER PTY Mode screen appears.

- 2 Select a program type from the list.
- 3 Touch **Search**.

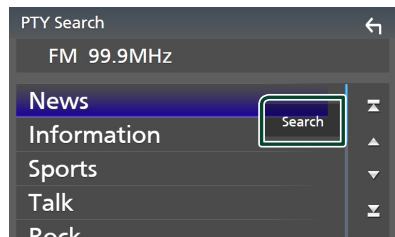



You can search for the station broadcasting the selected type of program.

## Bookmark

Stores tag information (title, artist, album, URL, and description) about the song you are listening to now.

Detailed information and QR codes can be displayed according to the stored tag information.

### Bookmark registration

- 1 Touch  on the left side of the screen. Touch .

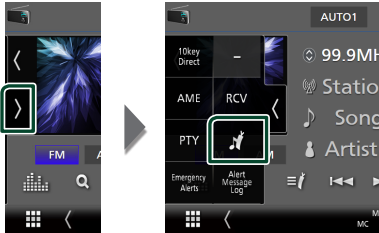

► Registers a bookmark.

#### NOTE

- Up to 100 bookmarks can be registered to this unit.

### Bookmark list

Displaying a list of registered bookmarks and detailed information and QR code of the song.

- 1 Touch .

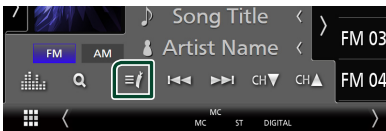

- 2 Select the desired bookmark from the list.

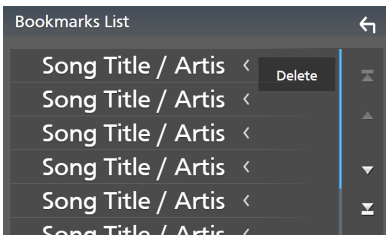

► The bookmark information appears.

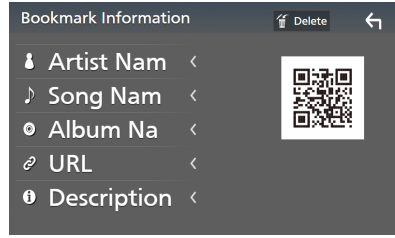

- 1  **Delete**

Deletes the bookmarks being displayed.

Touch **Delete** and then touch **Yes** on the confirmation screen.

### Bookmark delete

Deleting a bookmark.

- 1 Touch **Delete**.

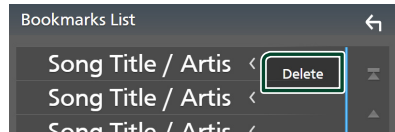

- 2 Select the bookmark to delete from the list.

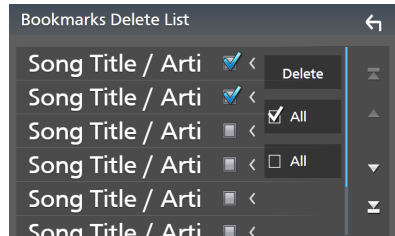

- 1  **All**

Select all bookmarks.

- 1  **All**

Erases all check marks.

- 3 Touch **Delete**.

► Confirmation message appears.

- 4 Touch **Yes**.

► All the selected bookmark(s) is deleted.

## Alert Message

This function is to receive alert messages. First, you need to turn on the "Emergency Alerts". (P.46)

### When an Alert Message comes



#### Snooze

The alert message is erased. Same alert message cannot be displayed for next 10 minutes.

#### Ignore

The alert message is erased. Same alert message cannot be displayed for next 12 hours.

#### Allow Alert

Touch to tune to that channel of HD Radio source.

### Display of the received Alert Message

You can read the received alert message afterward.

- 1 Touch  on the left side of the screen. Touch **Alert Message Log**.

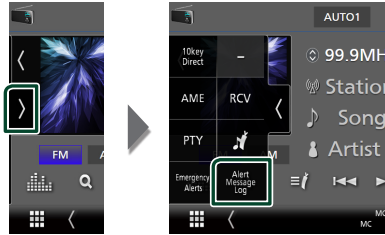

- 2 Select the desired Alert Message from the list.

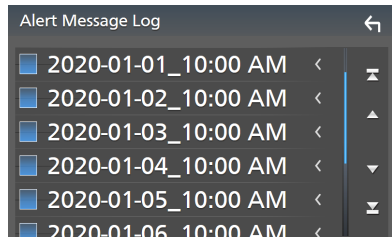

- The Alert Message appears.

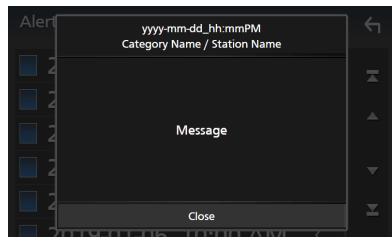

- 3 Touch **Close**.

# SiriusXM®

## SiriusXM® Basic Operation

Only SiriusXM® brings you more of what you love to listen to, all in one place. Get over 140 channels, including commercial-free music plus the best sports, news, talk, comedy and entertainment. Welcome to the world of satellite radio. A SiriusXM Vehicle Tuner and Subscription are required. For more information, visit [www.siriusxm.com](http://www.siriusxm.com).

To listen to the SiriusXM source, touch the **SiriusXM** icon on the source selection screen. (**P.15**)

### Activating subscription

- Check your Radio ID.  
The SiriusXM Satellite Radio ID is required for activation and can be found by tuning in Channel 0 as well as on the label found on the SiriusXM Connect tuner and its package. The Radio ID does not include the letters I, O, S or F.
- Activate the SiriusXM Connect Vehicle Tuner using either one of the two methods below:
  - For users in U.S.A.  
Online: Visit [www.siriusxm.com/activatenow](http://www.siriusxm.com/activatenow)  
Phone: Call SiriusXM Listener Care at 1-866-635-2349
  - For users in Canada:  
Online: Visit <https://www.siriusxm.ca/help/activation-help/>  
Phone: Call XM customer Care at 1-877-438-9677

### NOTE

- Set the remote control mode switch to AUD mode before starting operation, see **Switch the operation mode (P.96)**.
- To use SiriusXM® Satellite Radio, the optional accessory is necessary.

### Control screen

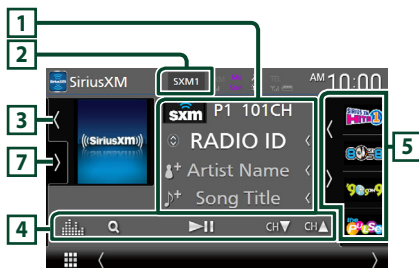

### Open the drawer

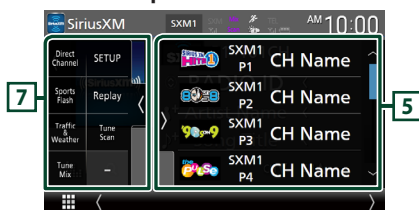

### Close the drawer

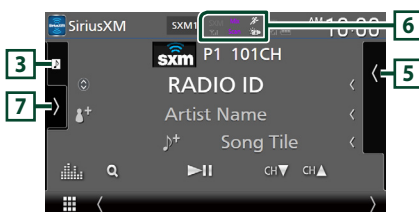

### 1 Information display

- Displays the information on the current channel: Channel Name  
**P#**: Preset number  
**#CH**: Channel number  
**Logo**: Channel logo  
Touching allows you to switch between Content A, Content B and Content C.  
Content A: Artist Name, Song Title  
Content B: Content Info, Category Name  
Content C: Channel Description, Similar Channels  
 : Touch for 2 seconds to register the artist of the current song as a Content Alert.  
 : Touch for 2 seconds to register the current song as a Content Alert.  
For details, see **Content Alerts (P.57)**.

- Change the text size of the information smaller when the "Small Audio Text" is set to "ON" in the User Interface screen **(P.82)**.

#### NOTE

- While getting contents, "Waiting" is showing on the display.

### 2 Band key

Switches among bands. (SXM1/SXM2/SXM3/SXM4)



### 3 Artwork

- Displays/hides artwork area.
- Displays the album artwork for most SiriusXM music channels



### 4 Operation keys

- **Q** : Display the Category search screen. For details on search operation, see **Category/Channel search (P.55)**.
- **▶||** : Plays or pauses. See **Replay (P.55)**.
- **CH▼ CH▲** : Selects a channel.
-  : Displays the Graphic Equalizer screen. **(P.90)**

### 5 Preset list

- Touching   allows you to change the display size.
- Recalls the memorized channel.
- When touched for 2 seconds, stores the currently being received channel in the memory.

### 6 Indicator display

Displays the "Mix" (TuneMix™), "Scan" (TuneScan™),  (Traffic&Weather), or  (SportsFlash™) indicator and the received signal strength of the SiriusXM tuner.

### 7 Function panel





Touch the left side of the screen to display the function panel. Touch again to close the panel.

- **Direct Channel**: Touch and enter the desired number. For details, see **Direct search (P.54)**.
- **SETUP**: Touch to display the SiriusXM SETUP screen. For details, see **SiriusXM SETUP (P.58)**.
- **Replay/Live**: Touch to turn on or off the replay mode. See **Replay (P.55)**.

### • Traffic & Weather



#### For SXV300 \*1

Traffic & Weather Now™ allows you to access the latest report whenever you want to hear it. Select your city from the set up menu (see **Select a City for Traffic & Weather (P.63)**) and touch **Traffic & Weather** to check the latest report. It will start from the beginning.

-  (White) : Played already.
-  (Green) : New information arrived.
-  (Purple) : Playing.
-  (Gray) : No information.

#### For SXV200 or SXV100 \*2

Turns the Traffic & Weather Jump function on or off.

-  (White) : Function on.
-  (Purple) : Playing.
-  (Gray) : Function off.

- **TuneScan** \*3 : Allows you to hear a few seconds of songs from each of the SmartFavorite music channels on the current preset band. See **TuneScan™ (P.56)**.
- **TuneMix** \*4 : When turned ON, shuffles the preset channels on P1-P6 to play a blend of songs from your favorite channels. See **TuneMix™ (P.56)**.
- **SportsFlash** \*4 : Displays during SportsFlash™. Touch to cancel the SportsFlash™ function and return to the previous channel. See **SportsFlash™ (P.58)** and **SportsFlash™ setup (P.62)**.

\*1 Compatible with SXV300 or later tuner models. It may take a few minutes after power on to get the first full report on your city. Traffic channels are not available in Canada.

\*2 When SXV200 or SXV100 is connected with this unit.

\*3 Compatible with SXV200 or later tuner models.

\*4 Compatible with SXV300 or later tuner models.

## Storing Channels in Preset Memory

You can store the current channel in memory.

- 1 Tune in the channel you wish to store in the memory.
- 2 Touch **Direct Channel** on the right side of the screen.

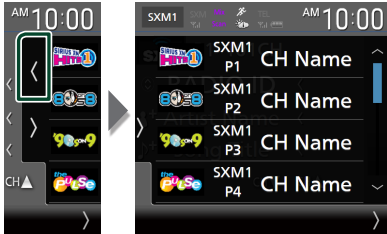

- 3 Touch **SXM(1-4) P(1-6)** in which you want to store the channel for 2 seconds until a beep sounds.

## Preset select

You can list and select memorized channels.

### To select from the preset list

- 1 Touch **Direct Channel** on the right side of the screen. Select a channel from the list.



## Direct search

You can tune in a channel directly.

- 1 Touch **Direct Channel** on the left side of the screen. Touch **Direct Channel**.



- 2 Enter the channel number and touch **Enter**.

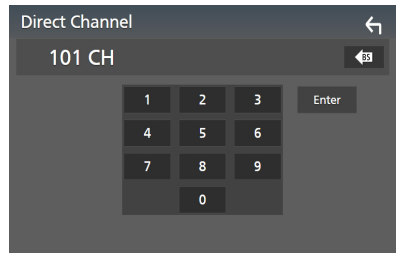

### NOTE

- To clear the number you entered, touch **BS**.

## Category/Channel search

You can specify the desired category and select a channel.

### 1 Touch **Q**.

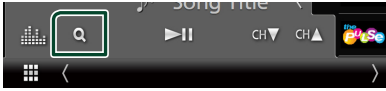

### 2 Select a category.

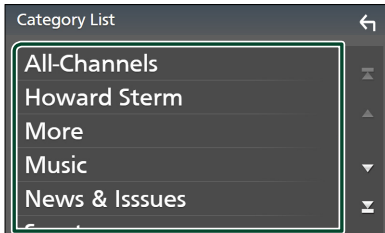

► Channel list appears.

### 3 Select the desired content from the list.

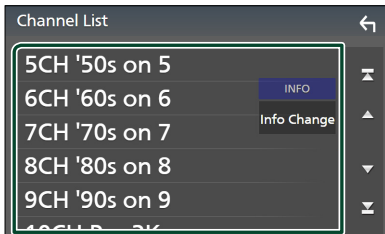

#### NOTE

- All channels in the selected category appear.
- Touching **All-Channels** displays all channels.
- Touch **Info Change** in the channel list. Select a desired item:  
content info, channel name, artist name, song title, category name.
- Categories which have the prefix "Featured -" are Featured Favorites.
- Featured Favorites are groups of channels that are created by the SiriusXM Programming department allowing you to discover new channels. Featured Favorite channels are dynamic and can change often, allowing you to discover new channels.
  - You can set whether to be notified when the featured seasonal theme is updated. **(P.63)**

## Replay

You can replay the last 60 minutes of the program from the current channel.

### 1 Touch **▶II** or **Replay** on the function panel.

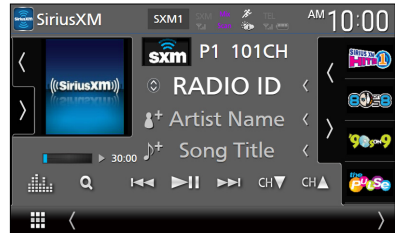

Press to skip to the previous/next track.

Press and hold to rewind or fast forward. (It will be cancelled automatically after about 50 seconds.)



Plays or pauses.

### ■ **Replay time bar/Play mode indicator**

Displays the recorded data capacity and playback position.

▶, ▶▶, etc.: Current play mode indicator



Displays a list of recorded data on a program basis.

### 2 Touch **Q** to display an Instant Replay List screen.

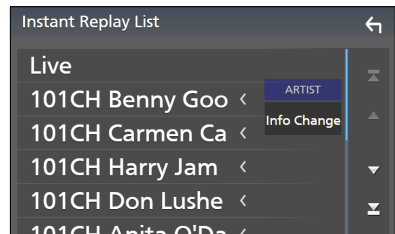

### ■ **Instant Replay List**

Touching this plays back the displayed program.

**Live**: Touch to return to the live music/content.

### ■ **Info Change**

Touch **Info Change**. Select a desired item:  
content info, channel name, artist name, song title, category name.

### To return to live music/content

- 1 Touch the left side of the screen.
- 2 Touch **Live**.

## TuneMix™

TuneMix™ plays a unique blend of songs from your Preset music channels of the current SiriusXM Preset Band, allowing you to build a custom channel from as few as two to as many as 6 music channels. You can even skip songs you don't want to hear.

- 1 Touch  on the left side of the screen. Touch **TuneMix** to set ON or OFF.



### NOTE

- Compatible with SXV300 or later tuner models.

## SmartFavorites, TuneStart™

Preset channels 1 through 6 of the current band are SmartFavorites channels. The SiriusXM Vehicle Tuner automatically buffers the broadcast audio content of the SmartFavorites channels in the background.

You can rewind and replay up to 30 minutes of any of the missed news, talk, sports or music content on SmartFavorites channels. (See **Replay (P.55)**)

When tuning in a SmartFavorites channel, songs will be played from the beginning of each track (TuneStart™). You can enable/disable TuneStart. (See **TuneStart™ (P.63)**.)

### NOTE

- Compatible with SXV200 or later tuner models.

## TuneScan™

TuneScan™ is a feature that plays samples from the starts of multiple buffered songs from each of the SmartFavorites channels that predominantly play music selections. You have easy access to a large sampling of music content and can enjoy hearing a full song by stopping the scan on a song of interest.

- 1 Touch  on the left side of the screen.



- 2 Touch **TuneScan** to begin scanning your SmartFavorites channels.

You will hear a few seconds of the songs from each of the SmartFavorite channels.

- 3 While your favorite song is being played, touch **TuneScan** again to start listening to that song.



- Scan finishes and the song is played continuously.

### NOTE

- To cancel TuneScan™, touch the left side of the screen. Touch **TuneScan**.
- Touch and hold **TuneScan** to cancel TuneScan, and the music/content which was present on the channel before starting TuneScan will be played.
- Compatible with SXV200 or later tuner models.



## Traffic & Weather Now™

Traffic & Weather Now™ allows you to access the latest report whenever you want to hear it. First select your city in the set up menu. See **Select a City for Traffic & Weather (P.63)**.





- 1 Touch  on the left side of the screen.



- 2 Touch **Traffic & Weather**.

The report starts from the beginning. To stop and return to the previous channel, touch it again.

### Indicator display

-  (White) : Played already.
-  (Green) : New information arrived.
-  (Purple) : Playing.
-  (Gray) : No information.

### NOTE

- Compatible with SXV300 or later tuner models.

## Content Alerts

When a broadcast program related to the registered artist, song or team starts, an Alert Content List screen appears to allow you to switch the current channel to the relevant channel.

- 1 When the broadcast of the registered content starts, an Alert Content List screen appears.

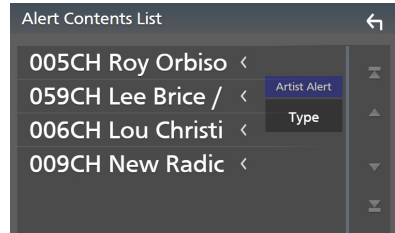

- 2 Select a content from the list.

### NOTE

- Touch **Type**. Select a desired item. Artist Alert, Song Alert, GameAlert™
- To learn how to register artists and songs for the Content Alert function, see  Information display in **SiriusXM® Basic Operation (P.52)**.
- To learn how to set up the Content Alerts function and select Teams for alerts, see **Content Alerts setup (P.60)**.

## SportsFlash™

SportsFlash™ will notify you when a big play happens during a game with one of your favorite sports teams. Choose to tune in and hear the play unfold like it was live. Continue listening to the game or return to your previous channel.

- 1 When a big play happens during one of the games, an Alert screen appears.

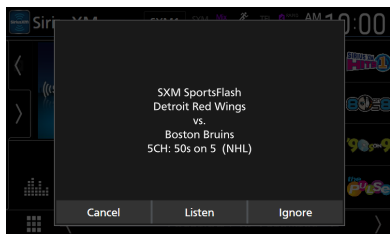

### ■ Listen

Touch to tune in that channel and play back the big play.

### ■ Ignore

Touch to cancel this specific SportsFlash alert. Touching **Ignore** will ignore this specific alert but will allow future alerts for this game.

### ■ Cancel

Touch to cancel SportsFlash alert. No alerts for this game will be displayed afterward.

## NOTE

- Compatible with SXV300 or later tuner models.
- To learn how to set up the SportsFlash alert function, see **SportsFlash™ setup (P.62)**.

## SiriusXM SETUP

- 1 Touch **SETUP** on the left side of the screen. Touch **SETUP**.



- SiriusXM SETUP screen appears.

See the following sections for each setting.

- Set up the parental code (**P.59**)
- Set up the Parental Control (**P.59**)
- Set up the skip channel select (**P.60**)
- Set up the Content Alerts (**P.60**)
- Set up the teams for SportsFlash™ (**P.62**)
- Select the city for Traffic & Weather Jump or Traffic & Weather Now™ (**P.63**)
- Select the Featured Bands Update Messages (**P.63**)
- Set up the TuneStart™ (**P.63**)
- Reset to the default settings (**P.63**)

## Parental code

You can set a SiriusXM parental code for Parental Control.

### 1 Touch **Parental Code** on the SiriusXM SETUP screen.

- Parental Pass Check screen appears.

#### NOTE

- The code number is set to "0000" as default.

### 2 Enter the current code number and touch **Enter**.

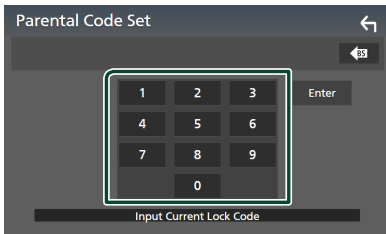

- Parental Pass 1st screen appears.

### 3 Enter the new code number and touch **Enter**.

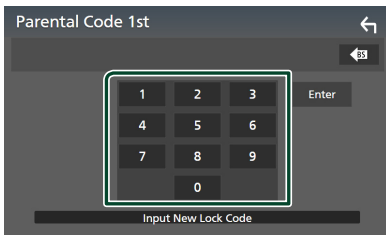

- Parental Pass 2nd screen appears.

### 4 Enter the same code number as that you entered in step 3 and touch **Enter**.

- The code number is confirmed and the SiriusXM parental code is now set.

## Parental Control

Parental Control is a feature that provides the user with the ability to prevent unauthorized access to mature content and user selected channels.

### 1 Touch **Parental Control** on the SiriusXM SETUP screen.

### 2 Touch **User, Mature or OFF**.

#### ■ **User**

Locks only the selected channels.

#### ■ **Mature**

Locks channels classified as "mature" only.

#### ■ **OFF**

Deactivates the parental mature and user locks.

### 3 Enter the parental code you originally input in as stated in *Parental code (P.59)* and touch **Enter**.

#### When selecting User

This allows you to limit access to any SiriusXM channel (Parental Lock Channel).

### 1 Touch **Parental Lock Channel Selection** on the SiriusXM SETUP screen.

- Parental Pass Check screen appears.

#### NOTE

- You need to set up a parental code beforehand as stated in *Parental code (P.59)*.

### 2 Enter the parental code you originally input as stated in *Parental code (P.59)* and touch **Enter**.

- Parental Lock Category Select screen appears.

### 3 Touch the desired category in the list.

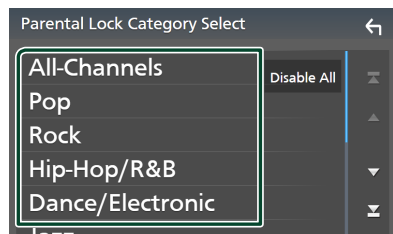

- Displays all channels in the selected category.

**NOTE**

- Touch **All-Channels** to display all channels.
- To delete the parental lock channel setting, touch **Disable All** and then touch **YES** on the confirmation screen.

**4 Touch each channel on the list and set to ON or OFF.**

**ON:** Locks the channel.

**OFF:** Unlocks the channel.

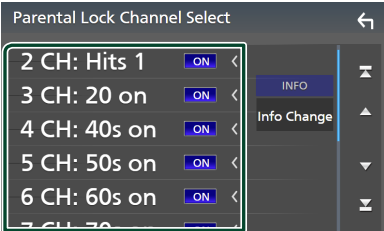

**NOTE**

- Touch **Info Change**. Select a desired item: content info, channel name, artist name, song title, category name.

**Skip channel select**

You can set the undesired channels to skip.

**1 Touch Skip Channel Select.**

- Skip Category Select screen appears.

**2 Touch the desired category from the list.**

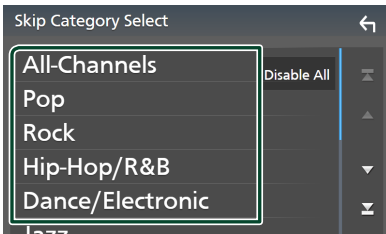

- Displays all channels in the selected category.

**3 Touch each channel in the list and set to ON or OFF.**

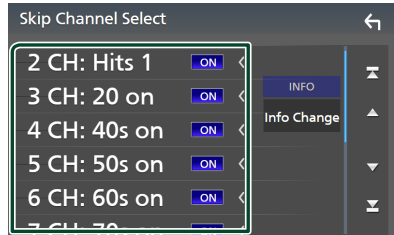

**NOTE**

- To delete the skip channel setting, touch **Disable All** and then touch **YES** on the confirmation screen.
- Touch **Info Change**. Select a desired item: content info, channel name, artist name, song title, category name.
- Direct Channel and Preset Memory functions allow you to select channels.

**Content Alerts setup**

**Activating content alert**

**1 Touch Content Alerts on the SiriusXM SETUP screen.**

- Content Alerts is turned on or off. Default is "ON".

**Selecting the content for Content Alerts**

**1 Touch Content Alerts Contents Set on the SiriusXM SETUP screen.**

**2 Select the content you want to set up.**

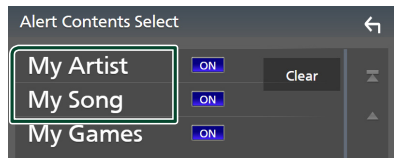

**NOTE**

- To cancel all alert contents, touch **Clear** and then touch **YES** on the confirmation screen.
- Select **OFF** for the content you want to deactivate the content alert for.

- 3 Touch each content list item you want to check or uncheck.

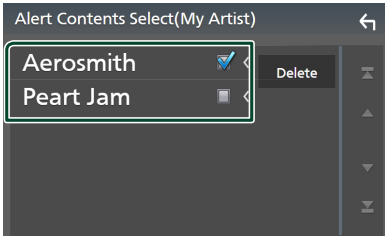

**NOTE**

• You can select (☑) up to 60 artists or songs.

- **To delete the Artist and Song**

- 1 Touch **Delete**.

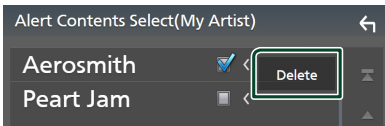

- 2 Touch the content(s) in the list you want to select.

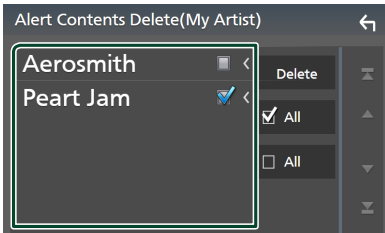

■  **All**  
Selects all contents.

■  **All**  
Clears all check marks.

- 3 Touch **Delete** and then touch **YES** on the confirmation screen.

**To select a Team**

Get alerted when your favorite sports team is playing on another SiriusXM channel with GameAlert™

- 1 Touch **My Games**.

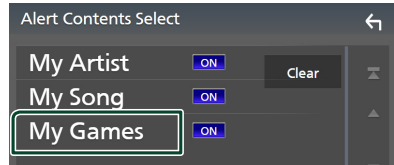

- 2 Touch the desired league in the list.

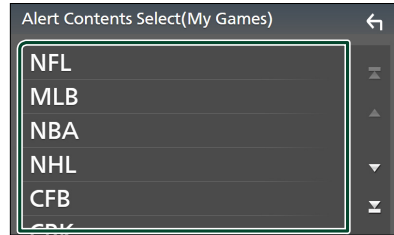

- 3 Touch the team(s) in the list you want to select.

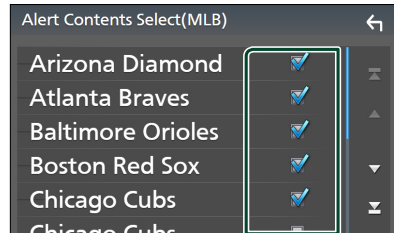

**NOTE**

• You can select (☑) up to 30 teams.

## SportsFlash™ setup

### Activating SportsFlash

1 Touch **SportsFlash** on the SiriusXM SETUP screen.

- SportsFlash is turned on or off. Default is "ON".

### Selecting SportsFlash Beep

1 Touch **SportsFlash Beep** on the SiriusXM SETUP screen.

- SportsFlash Beep is turned on or off. Default is "ON".

### Selecting the teams for SportsFlash

1 Touch **SportsFlash Team Set** on the SiriusXM SETUP screen.

- Team Set screen appears.

2 Touch **Edit**.

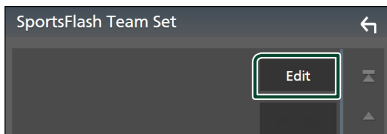

3 Touch the desired league in the list.

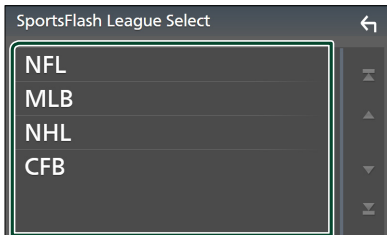

4 Touch each team(s) in the list you want to select.

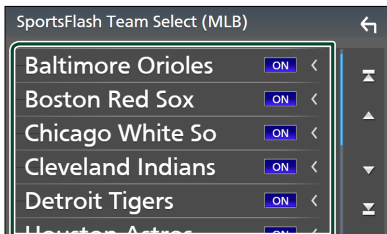

5 Touch  twice.

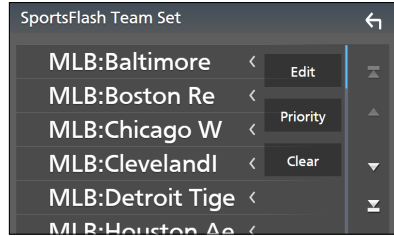

#### ■ Edit

Sets and removes teams.

#### ■ Priority

Sets the priority of a team.

#### ■ Clear

Removes all teams that have been set.

Touch **Clear**. When the confirmation screen appears, touch **YES**.

#### NOTE

- SportsFlash™ is available on SXV300 or later tuner models.
- Up to 50 teams can be added.

### Set the SportsFlash™ Team Priority

1 Touch **Priority**.

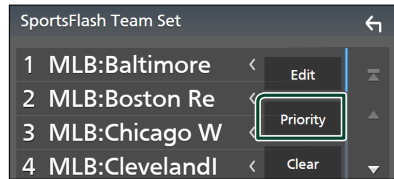

2 Set the priority of a team.

Each time you touch a Team, the priority is set of reset.



### 3 Touch **Done**.



#### NOTE

- Priority can be set on up to 5 teams.
- When priority has already been set for 5 teams, it cannot be set for any other team. Delete an unnecessary team.

### Select a City for Traffic & Weather

You can select a city for which you wish to receive SiriusXM Traffic & Weather broadcasts and hear them from the beginning.

- 1 Touch **Traffic & Weather City Select** on the SiriusXM SETUP screen.
- 2 Touch ◀ and ▶ to select a city.

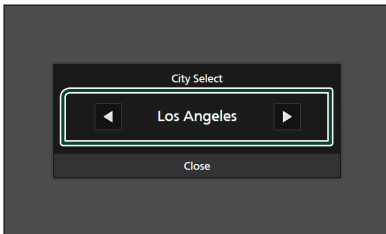

### 3 Touch **Close**.

### Selecting Featured Bands Update Messages

You can set whether to be notified when the featured seasonal theme is updated.

- 1 Touch **Featured Bands Update Messages** on the SiriusXM SETUP screen. Featured Bands Update Messages is turned on or off.

### TuneStart™

- 1 Touch **Tune Start** on the SiriusXM SETUP screen.  
The TuneStart is turned on or off.  
Default is "ON".

### Reset

- 1 Touch **SiriusXM Reset** on the SiriusXM SETUP screen.  
➤ Confirmation screen appears.
- 2 Touch **YES**.  
➤ All SiriusXM settings are reset to defaults.

# Bluetooth Control

Using the Bluetooth function allows you to use various functions such as listening to the audio file and making/receiving a call.

## Information for using Bluetooth® devices



Bluetooth is a short-range wireless radio communication technology for mobile devices such as cell-phones, portable PCs, and other devices.

Bluetooth devices can be connected without cables and communication with each other.

### NOTE

- While driving, do not perform complicated operations such as dialing numbers, using the phonebook, etc. When you perform these operations, stop your car in a safe place.
- Some Bluetooth devices may not be connected to this unit depending on the Bluetooth version of the device.
- This unit may not work for some Bluetooth devices.
- Connecting conditions may vary depending on your environment.
- Some Bluetooth devices are disconnected when this unit is turned off.
- The Bluetooth devices cannot be used while using Apple CarPlay.
- The Bluetooth currently connected with other device is disconnected when an iPhone compatible with Apple CarPlay is connected.

## About the cell-phone and Bluetooth audio player

This unit conforms to the following Bluetooth specifications:

### Version

Bluetooth Ver. 5.0

### Profiles

#### Cell-phone:

HFP (V1.7) (Hands Free Profile)

SPP (Serial Port Profile)

PBAP (Phonebook Access Profile)

#### Audio player:

A2DP (Advanced Audio Distribution Profile)

AVRCP (V1.6) (Audio/Video Remote Control Profile)

### Sound codec

LDAC (DDX9907XR / DMX957XR), SBC, AAC

### NOTE

- The units supporting the Bluetooth function have been certified for conformity with the Bluetooth Standard according to the procedure prescribed by Bluetooth SIG.
- However, it may be impossible for such units to communicate with your cell-phone depending on its type.



## Register the Bluetooth device

It is necessary to register the Bluetooth audio player or cell-phone in this unit before using the Bluetooth function.

You can register up to 10 Bluetooth devices.

### NOTE

- Up to 10 Bluetooth devices can be registered. If an attempt is made to register the 11th Bluetooth device, the Bluetooth device connected on the earliest date will be deleted to register the 11th one.
- This unit is compatible with the Apple Easy Pairing function. When an iPod touch or iPhone connected via USB terminal previously is connected again, an authentication dialog appears. Performing operation for authentication on this unit or iOS smartphone registers the smartphone as a Bluetooth device.

### 1 Press the **MENU** button.

- Popup menu appears.

### 2 Touch **SETUP**.



- SETUP Menu screen appears.

### 3 Touch **Bluetooth**.

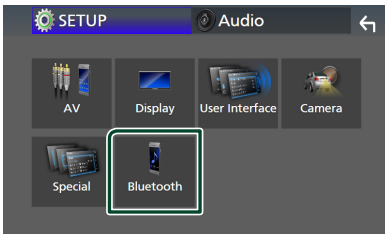

- Bluetooth Setup screen appears.

### 4 Touch **Select Device** on the Bluetooth Setup screen.

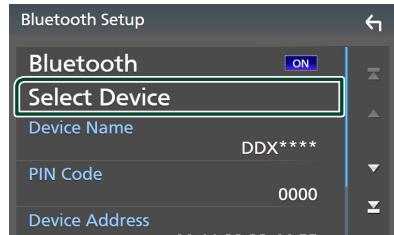

### 5 Touch **+0** on the Select Device screen.

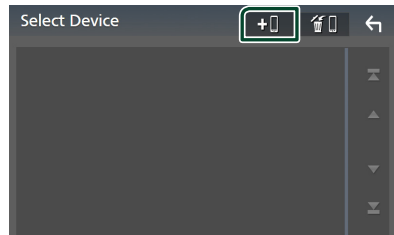

- Bluetooth pairing waiting dialog appears.

### NOTE

- You can also register an iPhone on the Apple CarPlay Device List screen. **(P.32)**
- When neither Apple CarPlay, Android Auto, nor a Bluetooth Hands-Free phone is connected, pressing and holding the **+0** button displays Bluetooth pairing waiting dialog.

### 6 Search for the unit ("DDX\*\*\*\*"/"DMX\*\*\*\*") from your smartphone/cell-phone.

Complete steps 6 to 9 within 30 seconds.

### 7 Operate your smartphone/cell-phone according to the displayed messages.

- **Confirm the request both on the smartphone/cell-phone.**

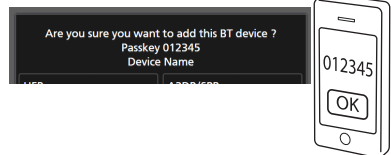

● **Input the PIN Code in your smartphone/cell-phone.**

PIN Code is set to "0000" as the default.

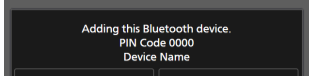

**8** Select the function you want to use.

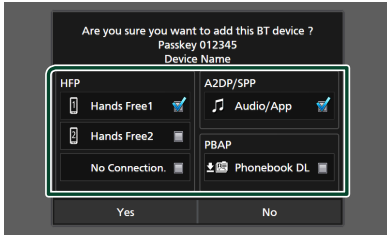

■ **HFP Hands Free1/Hands Free2/No Connection.**

Select the hands-free number to connect.

■ **A2DP/SPP Audio/App**

Select if you want to use the audio player app in your smartphone over A2DP, and the other apps in your smartphone over SPP.

■ **PBAP Phonebook DL**

Select if you want to transfer your phonebook data.

**NOTE**

- To select **Phonebook DL**, first select **Hands Free1** or **Hands Free2** for HFP.

**9** Touch **Yes**.

When data transmission and connection have completed, the Bluetooth connection icon appears on the screen.

**NOTE**

- When registering the iPhone that is available for Apple CarPlay wirelessly, a confirmation message appears.
  - **Yes**: Displays the Apple CarPlay screen for wireless connection.
  - **No**: Apple CarPlay is not connected. When using Apple CarPlay, see **Select an Apple CarPlay device (P.32)**.

## Bluetooth Setup

**NOTE**

- The Bluetooth Setup is disabled while using Apple CarPlay.

**1** Press the **MENU** button.

➤ Popup menu appears.

**2** Touch **SETUP**.

➤ SETUP Menu screen appears.

**3** Touch **Bluetooth**.



➤ Bluetooth Setup screen appears.

See the following section for each setting.

- Connect the Bluetooth device (P.66)
- Change the PIN Code (P.68)
- Change the device name (P.67)

■ **Connect the Bluetooth device**

**1** Touch **Select Device** on the Bluetooth Setup screen.

**2** Touch the name of the device you want to connect.

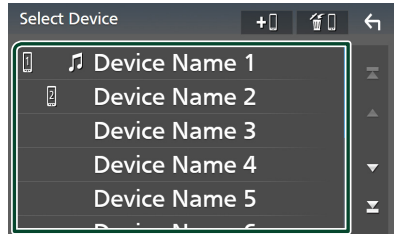

➤ Profile select screen appears.

**NOTE**

- If the icon is lighted, it means that the unit will use that device.
- You cannot select an Android smartphone connected as an Android Auto device.

### 3 Set each profile as follows.

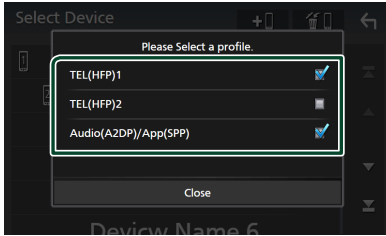

#### ■ TEL (HFP) 1, TEL (HFP) 2

Select when the device is connected with the unit as hands-free phone 1 or 2.

#### ■ Audio (A2DP)/App (SPP)

Select to interwork with an application installed in a smartphone or to use as an audio player.

### 4 Touch **Close**.

#### To delete the registered Bluetooth device

### 1 Touch on the Select Device screen.

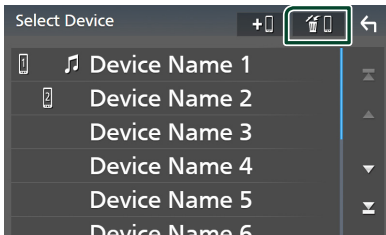

### 2 Touch the device name to check.

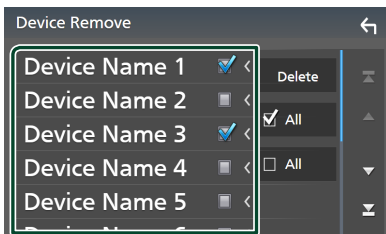

#### ■ All

Selects all Bluetooth devices.

#### ■ All

Clears all check marks.

#### NOTE

- You cannot select an Android smartphone connected as an Android Auto device.

### 3 Touch **Delete**.

- Confirmation message appears.

### 4 Touch **Yes**.

- All the selected device(s) is deleted.

#### NOTE

- If the device compatible with wireless Apple CarPlay is deleted, the same device is deleted from the Apple CarPlay device list screen.

## Change the device name

### 1 Touch **Device Name** on the Bluetooth Setup screen.

- Change Device Name screen appears.

### 2 Touch and hold .

### 3 Input the device name.



### 4 Touch **Enter**.

## Change the PIN Code

- 1 Touch **PIN Code** on the Bluetooth Setup screen.
  - Change PIN Code screen appears.
- 2 Touch and hold **BS**.
- 3 Input the PIN Code.

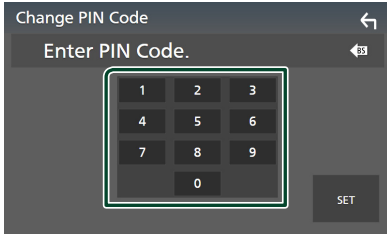

- 4 Touch **SET**.

## Playing the Bluetooth Audio Device

Most function can be controlled from the source control screen.

To select Bluetooth source, touch **Bluetooth** icon on the source selection screen. (P.15)

### NOTE

- The Bluetooth audio source is disabled while using Apple CarPlay.
- The Bluetooth audio source is disabled when the device set as Audio(A2DP)/App(SPP) is using Android Auto.

## Bluetooth basic operation



### 1 Artwork/VU meter

- Displays/hides artwork area.
- Touch to switch between the artwork and VU meter.

### 2 Play mode indicator/Playing time

▶, ||: Current play mode indicator

Meanings of individual icons are as follows:

- ▶ (play), ▶▶ (fast forward), ◀◀ (fast backward), || (pause), ■ (stop).

LDAC (DDX9907XR / DMX957XR): Indicates that an LDAC-compatible device is connected.



### 3 Operation keys \*

- 🔍: Searches for a file. See **File search** (P.70).

- ◀◀ ▶▶: Searches for the previous/next content.

Touch and hold to fast forward or fast backward. (It will be canceled automatically after about 50 seconds.)









- ▶: Plays.
- ||: Pauses.

- : Displays the Bluetooth Setup screen. (P.66)
- : Displays the Graphic Equalizer screen. (P.90)

#### 4 KENWOOD Music Mix

Bluetooth audio devices can be switched easily to play music. See **KENWOOD Music Mix** (P.69).

##### 5 / \*

- : Repeats the current track/folder. Each time you touch the key, repeat modes are switched in the following sequence: File repeat () , Folder repeat () , All songs repeat () , Repeat off ()
- : Randomly plays all tracks in the current folder. Each time you touch the key, random modes are switched in the following sequence: Folder random () , All random () , Random off ()

##### 6 Information display \*

- Displays the name of track information.
- Connected device name.
- Change the text size of the information smaller when the "Small Audio Text" is set to "ON" in the User Interface screen (P.82).

\* These items appear only when the audio player which supports AVRCP profile is connected.

#### NOTE

- The operation keys, indications and information displayed on the screen differ depending on the connected device.
- If the operation keys do not appear, operate from the player.
- Depending on your cell-phone or audio player, sound may be heard and controlled but text information may not appear.
- If the volume is too low, raise it on your cell-phone or audio player.
- It is recommended that you change the playback quality from "priority on sound quality" to "priority on stable connection" in the settings of your LDAC-compatible device so that the intermittent sound problem is less likely to occur. (DDX9907XR / DMX957XR)



## KENWOOD Music Mix

Up to 5 Bluetooth audio device can be connected and switched easily to play music.

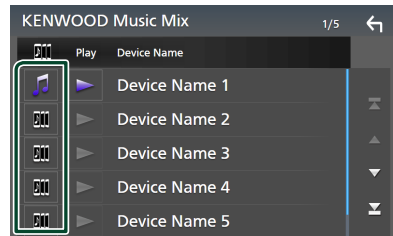

- 1 Touch .
  - ▶ A list of registered devices is displayed.

- 2 Touch  of device name you want to connect.
  - Touching  displays the Bluetooth device connection setup screen. (P.66)
  - Touching  on the left of the connected device ( ) disconnects this device.





- : Device used normally.
- : Device used for KENWOOD Music Mix

- 3 Touch  (white) on the left of the name of the device to be played.

 (white) changes to  (purple) and starts playback.



-  (Gray): Not connected.
-  (White): Connected.
-  (Purple): During playback.

- 4 Touch .

**NOTE**

- If a connected Bluetooth audio device is operated to play music, connections are switched.
- When a Bluetooth source is switched to another one, its settings are deleted and the connection is restored to the connection before source switching.
- You cannot select an Android smartphone connected as an Android Auto device.

**File search**

- 1 Touch **Q**.
- 2 Touch the desired file or folder.

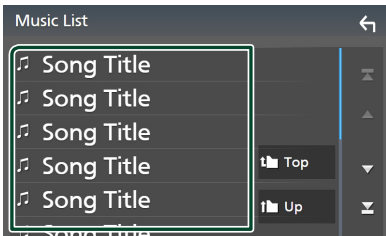

When you touch a folder its contents are displayed.

- 3 Touch the desired item in the content list.  
➤ Playback starts.

**NOTE**

- For operations in the list screen, see **List screen (P.18)**.

**Using the Hands-Free Unit**

You can use the telephone function by connecting the Bluetooth telephone to this unit.

**NOTE**

- If you use the hands-free function frequently, move the TEL short-cut key (icon) to the Home screen. **(P.16)**
- While Apple CarPlay or Android Auto is connected, the Bluetooth Hands-Free function and two Bluetooth devices connections cannot be used. Only the Apple CarPlay or Android Auto Hands-Free function can be used.

**Make a call**

- 1 Press the **HOME** button.
- 2 Touch **☐**.
- 3 Touch **TEL**.







➤ Hands Free screen appears.

**NOTE**

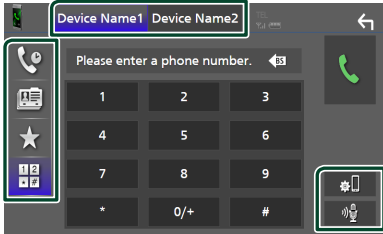
- If your cell-phone supports PBAP, you can display the phonebook and call lists onto the touch panel screen when the cell-phone is connected.
  - Phonebook: up to 1000 entries
  - Up to 50 entries including dialed calls, received calls, and missed calls

#### 4 Select a dialing method.



- : Call using call records
- : Call using the phonebook
- : Call using the preset number
- : Call by entering a phone number

#### ● Select the cell-phone to use

When you connect two cell-phones

- 1) Touch  to select the phone you want to use.

#### ● Bluetooth Setup

- 1) Touch .  
Bluetooth Setup screen appears.

#### ● Voice Recognition

- 1) Touch . (P.72)

#### NOTE



- Status icons such as battery and antenna icons may differ from those displayed on the cell-phone.
- Setting the cell-phone in the private mode can disable the hands-free function.

#### Call using call records

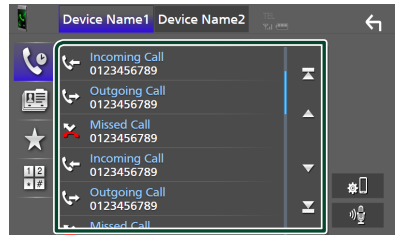
- 1 Touch .
- 2 Select the phone number from the list.



#### Call using the phonebook

- 1 Touch .
- 2 Touch  A-Z.
- 3 Select the initial.

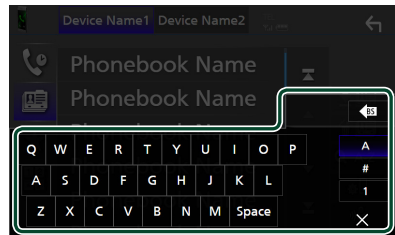

- Characters with no corresponding name will not appear.
- A first character with an accent character such as "ü" can be searched for with a non-accent character "u". A character with an accent character in a sentence cannot be searched for.

- 4 Select the person you want to call from the list.

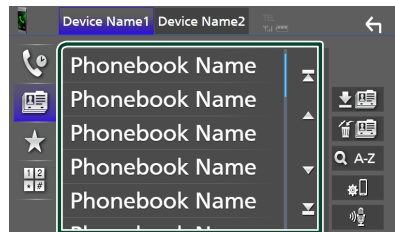

5 Select the phone number from the list.

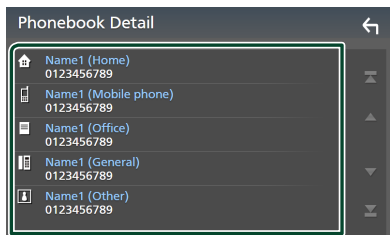

**NOTE**

- You can sort the phone numbers in the list by last name or first name. For details, see **Hands-Free Setup (P.75)**.

**Call using the preset number**

- 1 Touch .
- 2 Touch the name or phone number.

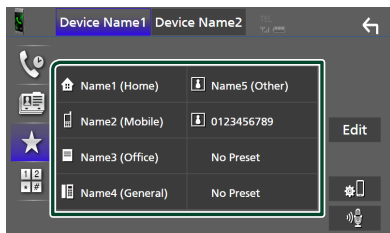

**Call by entering a phone number**

- 1 Touch .
- 2 Enter a phone number with number keys.

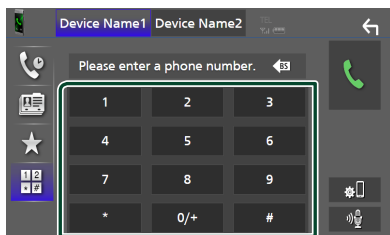

- 3 Touch .

**Voice Recognition**

You can access the voice recognition function of the cell-phone connected to this unit. You can search the cell-phone phonebook by voice. (The functionality depends on the cell-phone.)

- 1 Press the button for 1 second.

**DDX9907XR / DDX9705S**

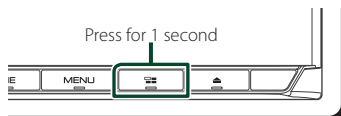

**DMX957XR / DMX907S / DMX9707S**

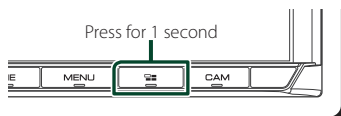

➤ Voice Recognition screen appears.



- 2 Start speaking.

**NOTE**

- You can use the voice recognition function by touching on the Hands Free screen.
- You can use the voice recognition function for the connected cell-phone if you selected **Hands Free1** or **Hands Free2** for HFP when registered.



## Receive a call

- 1 Touch  to answer a phone call or  to reject an incoming call.

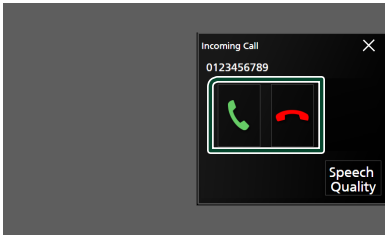

### NOTE

- When shifting the gear to the reverse (R) position and monitoring the picture from the rear view camera, this screen does not appear even if a call comes in.

## To end call

- 1 While talking, touch .

## Operations during a call

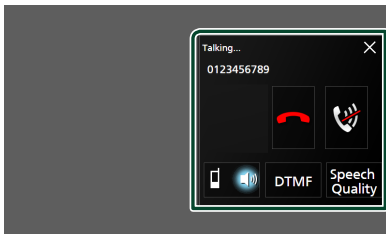

### ● Adjust the volume of your voice

- 1) Touch **Speech Quality**.
- 2) Touch ◀ or ▶ for **Microphone Level**.

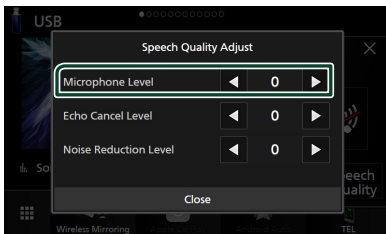

### ● Adjust the receiver volume

Press the ▼ or ▲ button.

## DDX9907XR / DDX9705

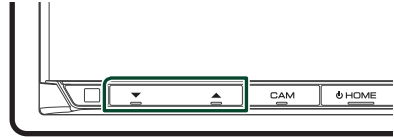

## DMX957XR / DMX907S / DMX9707S

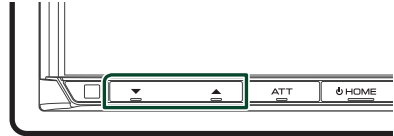



### ● Mute your voice

Touch  to mute or not to mute your voice.

### ● Output the dial tone

Touch **DTMF** to display the tone input screen. You can send tones by touching desired keys on the screen.

### ● Switching between speaking voice output destinations

Touching  /  each time switches speaking voice output destinations between the cell-phone and the speaker.

### ● Call-waiting

When you receive a new call while talking on the phone, you can answer the newly received call by touching . The current call is put on hold.

Each time you touch , the caller will change to the other one.

When you touch , the current call will end to be switched to the call waiting on hold.

### ● To close the Hands-Free popup screen

Touch ✕ to close the Hands-Free popup screen.

### To display it again

- ① Press the **HOME** button.
- ② Touch .
- ③ Touch **TEL**.

## Bluetooth Control

### Phone number preset

You can register frequently used phone numbers in this unit.

1 Touch .

2 Touch **Edit**.

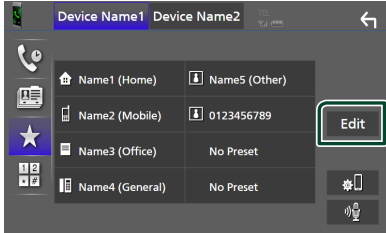

3 Select where to preset.

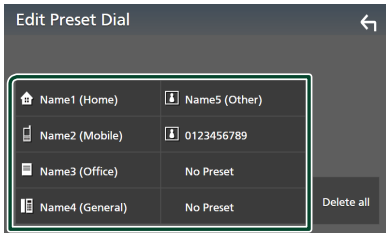

#### Delete all

To delete all preset numbers, touch **Delete all** and then touch **Yes** on the confirmation screen.

4 Select how to preset.

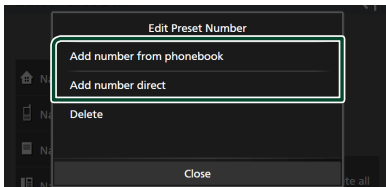

#### Add number from phonebook

Select the number to preset from the phonebook. See **Call using the phonebook (P.71)**.

#### Add number direct

Enter the telephone number directly and touch **SET**. See **Call by entering a phone number (P.72)**.

#### Delete

To delete a preset number, touch **Delete** and then touch **OK** on the confirmation screen.

### Phonebook transfer

You can transfer phonebook data from your Bluetooth smartphone using PBAP.

1 Touch .

2 Touch .

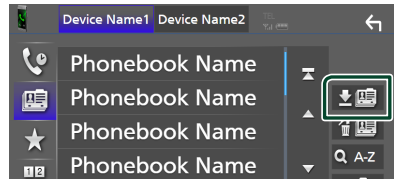

> Phonebook data transfer starts.

#### NOTE

- If the Phonebook contains more than 1000 entries, only 1000 entries are transferred. The 1001st and later entries are not transferred.
- If no Phonebook has been downloaded, touching **Download Phonebook Now** will start downloading the Phonebook.

### Phonebook deletion

1 Touch .

2 Touch the name to check.

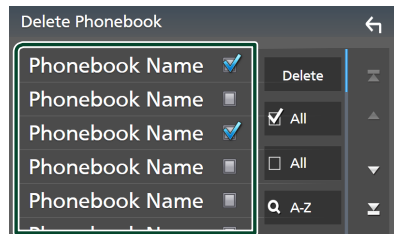

#### All

Checks all boxes.

#### All

Clears all check marks.

3 Touch **Delete**.

> Confirmation message appears.

4 Touch **Yes**.

## Hands-Free Setup

You can make various settings for the Hands-Free function.

### 1 Press the **MENU** button.

- Popup menu appears.

### 2 Touch **SETUP**.



- SETUP Menu screen appears.

### 3 Touch **Bluetooth**.

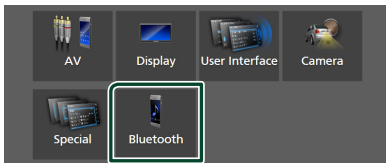

- Bluetooth Setup screen appears.

### 4 Touch **TEL SETUP**.

- TEL SETUP screen appears.

### 5 Set each function as follows.

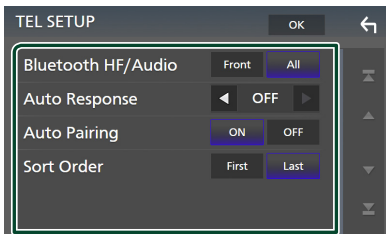

#### ■ **Bluetooth HF/Audio**

Select the speakers to output the sound from the cell-phone (such as phone call voice and ringing tone) and Bluetooth audio player.

**Front**: Outputs sound from the front speakers.

**All** (Default): Outputs sound from all speakers.

#### ■ **Auto Response**\*

Set the automatic response time to pick-up an incoming call.

**OFF** (Default): Turns off the Automatic response function.

**1/5/10/15/20/25/30**: Sets the ringing time (second).

#### ■ **Auto Pairing**

When set to "ON", the Apple Auto Pairing function is turned on to automatically register the iPod touch or iPhone connected to this unit.

**ON** (Default): Turns on the Apple Auto Pairing function.

**OFF**: Turns off the Apple Auto Pairing function.

#### ■ **Sort Order**

Set how to sort the data in the cell-phone phonebook.

**First**: Sorts data by the first name.

**Last** (Default): Sorts data by the last name.

\* Either the auto response time set on this unit or the time set on the cell-phone, whichever is shorter takes effect.

### 6 Touch **OK**.

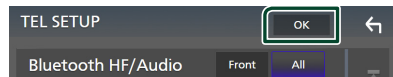

# Other External Components

## View Camera

### NOTE

- To connect a camera, see **Connecting the camera (P.108)**.
- To use a rear view camera, a REVERSE lead connection is required. **(P.104)**
- If **Rear Camera Interruption** is active the camera screen is displayed when you shift the gear to the reverse (R) position.
- The camera whose view was displayed last is kept and the same camera view will be displayed the next time. If its assignment setting is changed, the rear camera view is displayed.
- Rear/front camera interruption screen is not kept as the camera screen which will be displayed the next time.

### Display the camera screen

#### 1 Press the **MENU** button.

- Popup menu appears.

#### 2 Touch **Camera**.



- View camera screen appears.

#### 3 Adjust each item as follows.

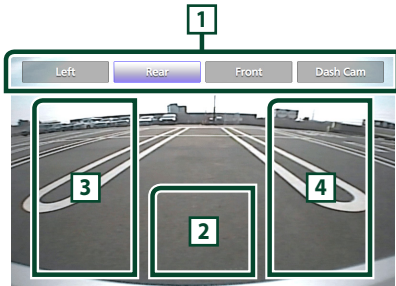

#### 1 **Camera Switching Keys** \*1

Touch to switch the view camera. It is necessary to set "Camera Assignment Settings" beforehand except "Rear". See **To set up the camera assignment settings (P.77)**.

#### 2 **Camera off**

Touch to exit the camera screen.

#### 3 **Switching the Guideline** \*2

Touching each time turns on or off the guideline.

#### 4 **Switching the Angle** \*2

Touching each time changes camera angles.

\*1 When two or more cameras of rear, front, dashboard, left, right, and 3rd are connected with this unit.

\*2 Only when the rear camera screen is displayed and CMOS-3xx series is connected with this unit as the rear camera.

### Camera Setup

#### 1 Press the **MENU** button.

- Popup menu appears.

#### 2 Touch **SETUP**.

- SETUP Menu screen appears.

#### 3 Touch **Camera**.

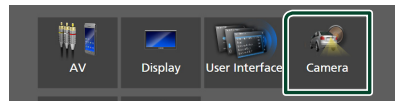

- Camera screen appears.

#### 4 Set each item as follows.

##### ■ **Camera Assignment Settings**

Set up the camera assignment. See **To set up the camera assignment settings (P.77)**.

##### ■ **Rear Camera Interruption**

**ON**: Displays the picture from the rear view camera when you shift the gear to the reverse (R) position.

**OFF (Default)**: Select this when no camera is connected.

##### ■ **Rear Camera Message** \*1

**Always display (Default)**: Always displays the caution message on the rear camera interruption screen.

**Clear after 5 seconds**: Displays the caution message for about 5 seconds on the rear camera interruption screen.

**■ Rear Camera Settings \*2**

Adjusts the CMOS-3xx series with ID 1 ("Rear Camera") set. For details, see the instruction manual of your camera.

**■ Parking Guidelines**

You can display parking guidelines to enable easier parking when you shift the gear to the reverse (R) position.

Default is "ON".

**■ Guidelines SETUP**

If you select **ON** for **Parking Guidelines**, you can adjust the parking guidelines. See **To adjust the parking guidelines (P.78)**.

**■ Front Camera Settings \*3**

Adjusts the CMOS-3xx series with ID 2 ("Front Camera") set. For details, see the instruction manual of your camera.

**■ Front Camera Interruption \*4**

**10 sec / 15 sec (Default) / 20 sec:** The front camera screen is displayed when return the gear from the reverse (R) position.

**OFF:** Cancel.

\*1 To use the function, it is necessary to set **Rear Camera Interruption** to **ON**.

\*2 When CMOS-3xx series is connected with this unit.

\*3 To use the function, it is necessary to connect CMOS-3xx series and to set **Camera Assignment Settings** to **Front**. (P.77)

\*4 To use the function, it is necessary to set **Rear Camera Interruption** to **ON** and to set **Camera Assignment Settings** to **Front**. (P.77)

**■ To set up the camera assignment settings**

**1** Touch **Camera Assignment Settings** on the Camera screen. (P.76)

**2** Select the item to set up.

**■ REAR VIEW CAMERA (DDX9907XR / DMX957XR)**

Change the HD camera picture quality setting when an HD camera is connected.

**■ FRONT VIEW CAMERA / DASH CAM**

Set the camera assignment from view camera connected to Front view camera/ Dashboard camera input terminal.

Change the HD camera picture quality setting when an HD camera is connected. (DDX9907XR / DMX957XR only)

**■ 3rd VIEW CAMERA**

Set the camera assignment from view camera connected to 3rd view camera input terminal.

**■ AV-IN**

Set the camera assignment from view camera connected to AV-IN input terminal.

**3** Select the view camera to set up.

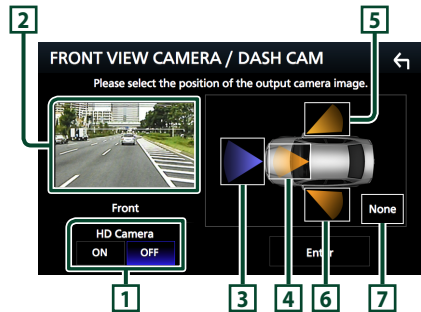

**1 Picture quality settings (DDX9907XR / DMX957XR) \*1**

Switch the picture quality setting when an HD camera for the rear/front view camera. "ON"/"OFF" (Default)

**2 Picture from view camera**

Displays the picture from the view camera connected to the input terminal to be set. (P.108)

**3 Front \*2**

Assign front position to the view camera connected to the selected input terminal.

**4 Dashboard Camera \*2**

Assign dashboard camera position to the view camera connected to the selected input terminal.

**5 Right \*2**

Assign right position to the view camera connected to the selected input terminal.

**6 Left \*2**

Assign left position to the view camera connected to the selected input terminal.

## Other External Components

### 7 None \*2

Assign no position to the view camera connected to the selected input terminal.

\*1 The **REAR VIEW CAMERA** and **FRONT VIEW CAMERA / DASH CAM** setting screens only.

\*2 Except the **REAR VIEW CAMERA** setting screen.

## 4 Touch Enter.

### NOTE

- The screen shot above is for the **FRONT VIEW CAMERA / DASH CAM** setting screen. It may be different from the ones for **REAR VIEW CAMERA**, **3rd VIEW CAMERA** and **AV-IN**.
- The Dashboard Camera can be selected when it is connected. (P.108)

## To adjust the parking guidelines

### NOTE

- Install the rear view camera in the appropriate position according to the instruction manual supplied with the rear view camera.
- When adjusting the parking guidelines, make sure to apply the parking brake to prevent the car from moving.

1 Touch **Parking Guidelines** in the Camera screen and set to **ON**. (P.76)

2 Touch **Guidelines SETUP** on the Camera screen.

3 Adjust the parking guidelines by selecting the  mark.

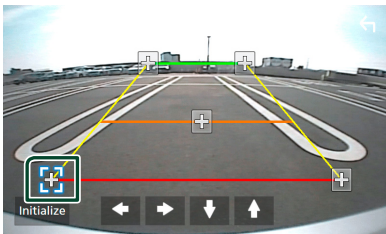

4 Adjusting the position of the selected mark.

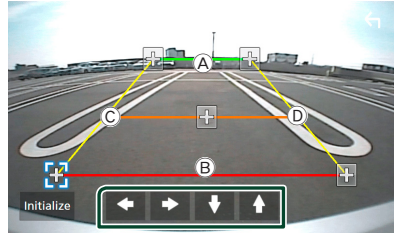

Make sure that lines (A) and (B) are horizontally parallel, and that lines (C) and (D) are of the same length.

### NOTE

- Touch **Initialize** and then touch **Yes** to set all the  marks to their initial default position.

## Use Dashboard Camera

A Dashboard Camera, DRV-N520 (optional accessory), connected to this unit lets you play video-recorded data and so on.

For details, see the instruction manual of the Dashboard Camera DRV-N520 (optional accessory).

### NOTE

- To connect a dashboard camera, see **Connecting the camera** (P.108).
- To use the dashboard camera function, it is necessary to set "Camera Assignment Settings" to "Dashboard Camera". (P.77)

Display the dashboard camera screen

- 1 Press the **MENU** button.
  - Popup menu appears.

## 2 Touch Camera .

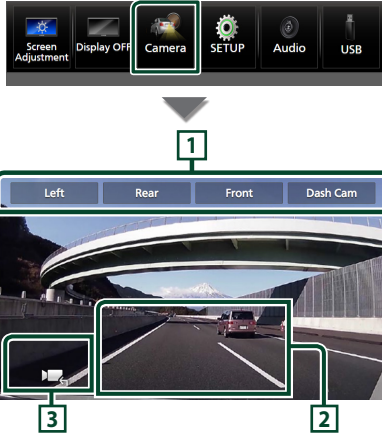

### 1 Camera Switching Keys

Touch to switch the view camera. It is necessary to set "Camera Assignment Settings" beforehand except "Rear". See **To set up the camera assignment settings (P.77)**.

### 2 Camera off

Touch to exit the camera screen.

### 3 Key display

Touch to display the dashboard camera control keys.

## External audio/video players (AV-IN)

- 1 Connect an external component to the AV-IN input terminal. (P.105)
- 2 Select **AV-IN** as the source. (P.15)
- 3 Turn on the connected component and start playing the source.

### NOTE

- To select the AV-IN source, it is necessary to set "AV-IN" to "None" in **Camera Assignment Settings**. (P.77)

## OEM Features Operation





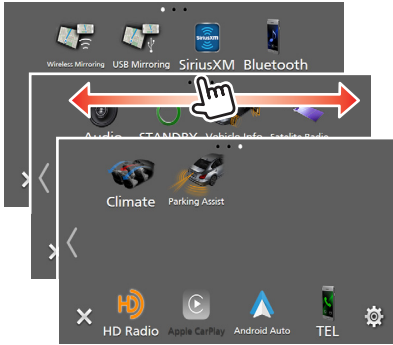

By connecting this unit to the bus system of the vehicle using an iDataLink (commercially available), This unit can display vehicle information when connected to the bus system of the vehicle using an iDataLink (commercially available).

- 1 Press the **HOME** button.
  - HOME screen appears.
- 2 Touch  on the HOME screen.

## Other External Components

### 3 Touch icon.



	• Displays the control screen of the Bluetooth Hands Free function provided for the vehicle.
	• Displays information about the tire pressures of the vehicle. *
	• Displays the control screen of the satellite radio source provided for the vehicle.
	• Displays the control screen of the media player source provided for the vehicle.
	• Displays the control screen of the Bluetooth streaming source provided for the vehicle.
	• Displays information about the Radar Detector. *
	• Displays information about the instruments such as a speedometer.
	• Displays information about the air conditioner of the vehicle. *
	• Displays information about the Parking Distance Sensor of the vehicle.

\* These ADS adapter features are displayed as the widget on the Home screen. **(P.14)** You can display the relevant screens by touching the widget.

#### NOTE

- Displayable screens, key names, and screen names vary depending on the type of the connected iDataLink and the model of the vehicle. For more details, access the following URL:  
[www.idatalink.com/](http://www.idatalink.com/)



# Setup

## Monitor Screen Setup

You can adjust the image quality of video, menu screen, etc.

### 1 Press the **MENU** button.

► Popup menu appears.

### 2 Touch **Screen Adjustment**.



► Screen Adjustment screen appears.

### 3 Adjust each setting as follows.

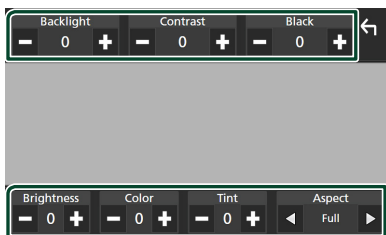

#### ■ **Backlight/Contrast/Black/ Brightness/Color/Tint**

Adjust each setting.

#### ■ **Aspect**

Select a screen mode.

**Full**: Changes the aspect ratio of video and displays video fully on the screen.

**Normal**: Displays video at the ratio of 4:3.

#### **Auto**:

DVD, VCD and disc media: 16:9 video is displayed in the Full mode and 4:3 video is displayed in the Regular mode.

USB device: Displays video fully (vertically or horizontally) with no ratio change.

#### **NOTE**

- Settings to adjust vary depending on the current source.

## System Setup

### 1 Press the **MENU** button.

► Popup menu appears.

### 2 Touch **SETUP**.

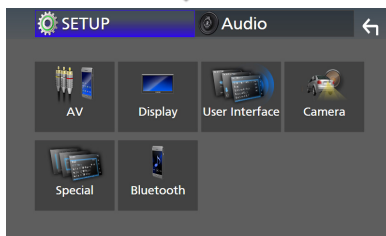
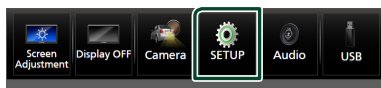

See the following section for each setting.

- Set up **AV (P.86)**
- Set up **display (P.84)**
- Set up the **user interface (P.82)**
- Set up **camera (P.76)**
- Set up **special (P.83)**
- Set up **Bluetooth (P.66)**

## User Interface Setup

You can setup user interface parameters.

### 1 Press the **MENU** button.

➤ Popup menu appears.

### 2 Touch **SETUP**.

➤ SETUP screen appears.

### 3 Touch **User Interface**.

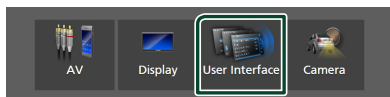

➤ User Interface screen appears.

### 4 Set each parameter as follows.

#### ■ **Small Audio Text**

Change the text size for the source control screen.

**ON** : Change the text size smaller.

**OFF** (Default): Cancel.

#### ■ **Beep**

Turn the key touch tone on or off.

Default is "ON".

#### ■ **Widget SETUP**

Set up the widget displayed on the Home screen. (P.21)

#### ■ **Parking Assist Display**

When an ADS adapter is connected, you can display information about obstacles around the car.

**ON** : Always displays information.

**Dyn.** (Default): Displays information when the sensor detects obstacles.

**OFF** : Cancels this function.

This can be set when the iDatalink (commercially available) is connected.

#### ■ **Parking Assist Position**

Select where to display information about obstacles on the screen (left or right).

"Left"/"Right" (Default)

This can be set when the iDatalink (commercially available) is connected.

#### ■ **Language Select**

Select a language.

#### ■ **Touch Panel Adjust**

(DDX9707S / DMX9707S)

Adjust the sensing position of the touch panel. (P.82)

#### ■ **Time Format**

Select the time display format.

"12-Hour" (Default)/"24-Hour"

#### ■ **Clock**

**GPS-SYNC** (Default): Synchronizes the clock time with the GPS.

**Manual** : Set the clock manually.

#### ■ **Time Zone**

Select the time zone.

#### ■ **Clock Adjust**

If you select **Manual** for Clock, adjust the date and time manually. (P.83)

## Touch panel adjustment

### 1 Touch **Touch Panel Adjust** on the User Interface screen.

➤ Touch Panel Adjust screen appears.

### 2 Follow the instruction on the screen and long touch the center of each .

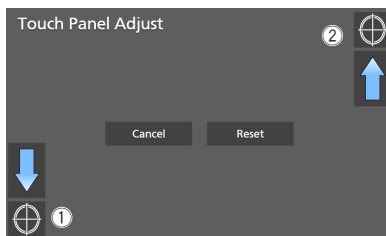

#### NOTE

- To cancel the touch panel adjustment, touch **Cancel**.
- To reset it to the default, touch **Reset**.

## Adjust the date and time manually

- 1 Touch **Clock** on the User Interface screen.
- 2 Select **Manual**.
- 3 Touch **Time Zone** on the User Interface screen.
- 4 Select the time zone.
- 5 Touch **Clock Adjust** on the User Interface screen.
- 6 Adjust the date, then adjust the time.

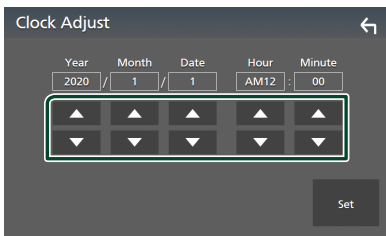

- 7 Touch **Set**.

## Special Setup

You can setup special parameters.

- 1 Press the **MENU** button.
  - Popup menu appears.
- 2 Touch **SETUP**.
  - SETUP screen appears.
- 3 Touch **Special**.

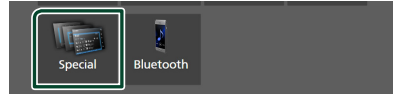

- Special screen appears.

- 4 Set each parameter as follows.

### ■ DEMO

Select the demonstration mode. Default is "ON".

### ■ Software Information

Confirm the software version of this unit.

#### (P.83)

### ■ Open Source Licenses

Display the open source licenses.

### ■ Initialize

Touch **Initialize** and then touch **Yes** to set all the settings to the initial default settings.

- Audio SETUP Memory is not initialized.

## Software Information

You can confirm the software version of this unit.

- 1 Touch **Software Information** in the Special screen.
- 2 Confirm the software version.

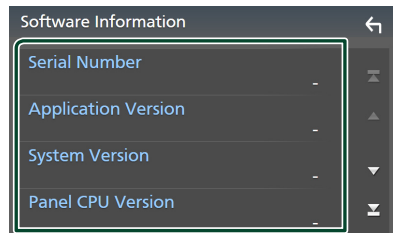

## Setup

### NOTE

- For how to update the software, see the relevant update procedure manual which comes with the software.

## Display Setup

- 1 Press the **MENU** button.  
➤ Popup menu appears.
- 2 Touch **SETUP**.  
➤ SETUP screen appears.
- 3 Touch **Display**.

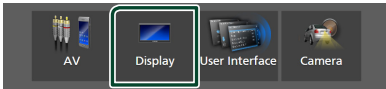

➤ Display screen appears.

- 4 Set each parameter as follows.

### ■ Dimmer

Select the dimmer mode.

**OFF**: Does not dim the display and keys.

**ON**: Dims the display and keys.

**SYNC** (Default): Turns the dimmer function on or off when the vehicle light control switch is turned on or off.

### ■ OSD Clock

Select if you want to display the clock while the screen is off, or while watching DVD video and video files (USB, Disc media), etc.

### ■ Key Color

You can set the key illumination color. (P.84)

### ■ Wallpaper Customize

You can change the wallpaper image or color. (P.85)

### ■ Viewing Angle

(DMX907S / DMX9707S)

If it is hard to see the image on the screen evenly, adjust the viewing angle. The smaller the (negative) value, the more whitish the image on the screen looks.

"0" (Default)"/"-1"/"-2"/"-3"

### ■ Screen transition effect

Select whether to use the screen transition effect when the source control screen is switched to the Home screen.

"ON" (Default)"/"OFF"

## Customizing the key color

You can set the key illumination color.

- 1 Touch **Key Color** on the Display screen.
- 2 Touch the desired color.

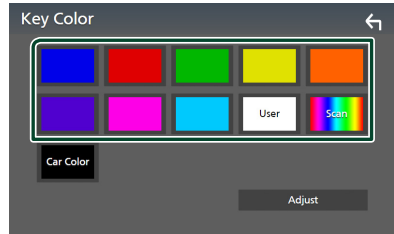

### ■ User

The color you have set in the process of **Adjust** is registered.

### ■ Scan

You can set the key color to continuously scan through the color spectrum.

### ■ Car Color

This can be selected when a compatible ADS adapter is connected.

- 3 Touch .

### To register an original color

You can register your original color.

- 1 Touch **User** on the Key Color screen.
- 2 Touch **Adjust**.
- 3 Use **-** and **+** to adjust each color value.

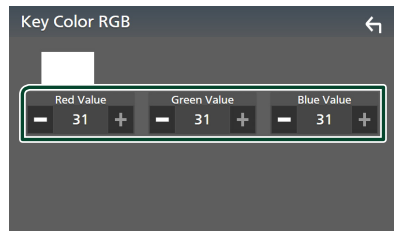

- 4 Touch .

## Change the wallpaper image or color

- 1 Touch **Wallpaper Customize** on the Display screen.
- 2 Select an image.

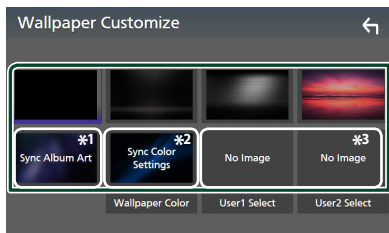

\*1 The album art currently being displayed is used as a wallpaper.

\*2 Select a wallpaper color in advance.

\*3 Select an original image in advance.

### To select wallpaper color

- 1 Touch **Wallpaper Color** on the Background screen.
- 2 Select a wallpaper color.

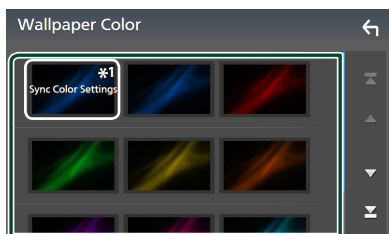

\*1 The color you have selected at **Key Color** is added on the image. If you select "Scan" at **Key Color**, you cannot select this image.

- 3 Touch .

### To register an original image

You can load an image from the connected USB device and set it as the wallpaper image. Before starting this procedure, it is necessary to connect the device which has the image to load.

- 1 Touch **User1 Select** or **User2 Select** on the Wallpaper Customize screen.
- 2 Select the image to load.

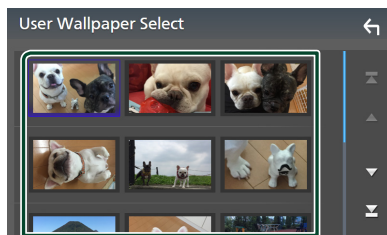

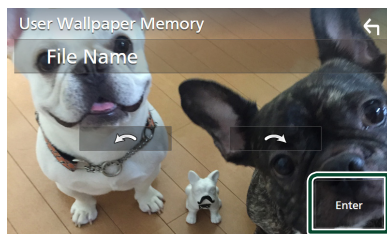

- 3 Touch **Enter**.



- The selected image is loaded and the display returns to the Wallpaper Customize screen.

#### NOTE

- Touching  rotates the image counter-clockwise.
- Touching  rotates the image clockwise.
- Picture files: JPEG (.jpg, .jpeg), PNG (.png), BMP (.bmp)

## AV Setup

You can set AV parameters.

### 1 Press the **MENU** button.

- Popup menu appears.

### 2 Touch **SETUP**.

- SETUP screen appears.

### 3 Touch **AV**.

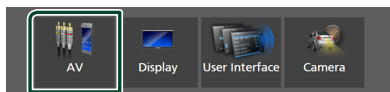

- AV screen appears.

### 4 Set each parameter as follows.

#### ■ **Android Auto Device Select**

Select the device to be used in the Android Auto mode. (P.35)

#### ■ **Apple CarPlay Device List**

Select the device to be used in the Apple CarPlay mode. (P.32)

#### ■ **Speech Quality Adjust**

Adjust the speech quality.

**Microphone Level** : Adjust the level of microphone gain. Default is "0".

**Echo Cancel Level** : Adjust the level of echo cancellation. Default is "0".

**Noise Reduction Level** : Reduce the noise generated in the surrounding environment without changing the microphone volume. Use this function when the voice of caller is not clear. Default is "0".

#### ■ **AV-OUT**

You can select an AV source to be output from the AV OUTPUT port.

OFF, AV-IN, DISC (DDX9907XR / DDX9707S only), USB or iPod

- You cannot select AV-IN if the AV-IN input terminal is used for camera.
- You cannot select iPod if it is connected via Bluetooth.
- If you select USB, iPod, DISC (Music CD/Disc media), Bluetooth audio, Radio or HD Radio as the main source, you cannot select USB, iPod or DISC (Music CD/Disc media) as the AV output source.

- If you select Wireless Mirroring, Apple CarPlay or Android Auto as the main source, you cannot select DISC (Music CD/Disc media), USB or iPod as the AV output source.

#### ■ **Driving Position**

Select the driving position (left or right).

"Left" (Default)/"Right"

#### ■ **Wi-Fi SETUP**

You can change the device name and display the device address, password. See **Change the device name (P.86)**.

#### ■ **OEM SETUP**

Confirm the information about or change the settings for using the ADS adapter.

#### ■ **Reset Android Auto Wireless Connection**

You can change the password for wireless Android Auto.

The system of the unit is rebooted after selecting **YES**.

## Change the device name

### 1 Touch **Wi-Fi SETUP** on the AV screen.

### 2 Touch **Device Name**.

- Change Device Name screen appears.

### 3 Touch and hold **BS**.

### 4 Input the device name.



### 5 Touch **Enter**.

# Controlling Audio

You can adjust various settings such as audio balance or subwoofer level.

## 1 Press the **MENU** button.

➤ Popup menu appears.

## 2 Touch **Audio**.

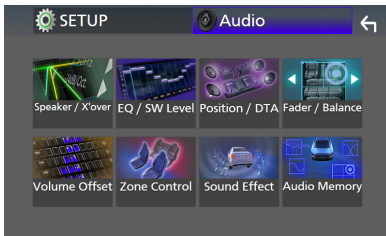
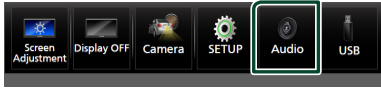

See the following section for each setting.

- Set up Speaker / X'over (P.88)
- Controlling EQ / SW Level (P.90)
- Set Position / DTA (P.94)
- Controlling Fader / Balance (P.90)
- Set Volume Offset (P.91)
- Performing Zone Control (P.92)
- Set Sound Effect (P.93)
- Use Audio Memory (P.95)

## 3-way speaker system setup (DDX9907XR / DMX957XR / DMX907S)

Select the appropriate crossover network mode for the speaker system used (2-way or 3-way speaker system).

### ▲ CAUTION

- Connecting 3-way speakers with the 2-way mode selected can break the speakers.

## 1 Press the **HOME** button.

➤ HOME screen appears.

## 2 Touch **Source**.

➤ Source selection screen appears.

## 3 Touch **STANDBY**.

## 4 Press the button ① followed by the button ② for 1 second at the same time.

### DDX9907XR



### DMX957XR / DMX907S



➤ Speaker system select screen appears.

## 5 Select the crossover network mode.

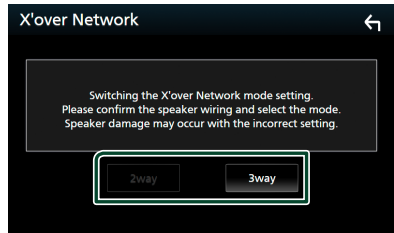

➤ A confirmation screen appears.

## 6 Touch **Yes**.

### NOTE

- When the 3-way speaker system is selected, the following functions are disabled.
  - Front focus of Listening Position / DTA
  - Fader for Controlling General Audio
  - Zone Control
  - Selection of the speakers to output sound from the cell-phone of Bluetooth HF/Audio
  - Beep for User Interface Setup
- When the dual zone is selected and audio source other than "OFF" is selected as Rear Source, the speaker system cannot be switched.

## Speaker / X'over setup

- 1 Press the **MENU** button.  
➤ Pop-up menu appears.
- 2 Touch **Audio**.  
➤ Audio screen appears.
- 3 Touch **Speaker / X'over**.



- 4 Select a car type.

You can select the car type and speaker network, etc.

When you select your car type, the Delay Time Alignment is activated automatically (for timing adjustment of sound output for each channel) to have the highest surround effects.



- 5 Touch the speaker (1) you wish to adjust and set each parameter (2) as follows.

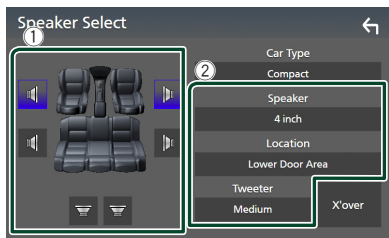

### ■ Speaker

You can select a speaker type and its size to get the best sound effects.

When the speaker type and size are selected, the speaker crossover network is set automatically.

### ■ Location (Only for Front, Rear)

Select the speaker position you have installed.

### ■ Tweeter (Only for Front)

You can set up the tweeter when you are selecting front speakers.

None, Small, Medium, Large

### ■ X'over

Display the speaker crossover setup screen.

You can adjust the crossover frequency that was set automatically when you selected the speaker type.

For details, see **Crossover network setup (P.88)**

### When Speaker network is set to 3-way:

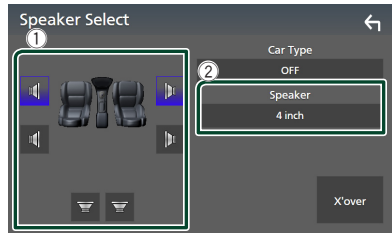

### NOTE

- For how to switch to the 3-way speaker system, see **3-way speaker system setup (P.87)**. Connecting 3-way speakers with the 2-way mode selected can break the speakers.
- Select "None" if you have no speakers.

## ■ Crossover network setup

You can set the crossover frequency of speakers.

- 1 Touch **X'over**.

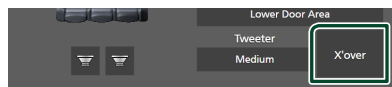

- 2 Touch the speaker to set up.





### 3 Set each parameter as follows.

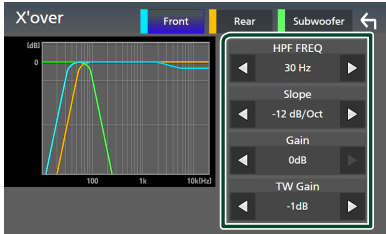

#### ■ HPF FREQ

High Pass Filter adjustment. (When Front or Rear is selected on the Speaker Select screen)

#### ■ LPF FREQ

Low Pass Filter adjustment. (When Subwoofer is selected on the Speaker Select screen)

#### ■ Slope \*1

Set a crossover slope.

#### ■ Gain

Adjust the gain of the front speaker, rear speaker, or subwoofer.

#### ■ TW Gain \*2

Adjust the tweeter level. (When Front is selected on the Speaker Select screen)

#### ■ Phase Inversion \*3

Set the phase of subwoofer output.  
Check **Phase Inversion** to shift the phase 180 degrees. (When Subwoofer is selected on the Speaker Select screen)

\*1 Only when "LPF FREQ"/"HPF FREQ" is set to a mode other than "Through" in **X'over**.

\*2 Only when "Tweeter" is set to "Small", "Medium", "Large" in **Speaker Setup**.

\*3 Only when "Subwoofer" is set to a mode other than "None" in **Speaker Setup**.

### When Speaker network is set to 3-way:

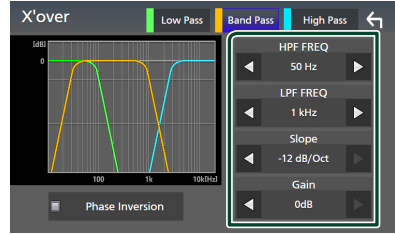

#### ■ FREQ (High Pass)

High Pass Filter adjustment.

#### ■ HPF FREQ, LPF FREQ (Band Pass)

Band Pass Filter adjustment. (When Mid Range Speaker is selected on the Speaker Select screen)

#### ■ FREQ (Low Pass)

Low Pass Filter adjustment. (When Woofer is selected on the Speaker Select screen)

#### ■ Slope \*1 \*2

Set a crossover slope.

#### ■ Gain

Set the gain of each speaker.

#### ■ Phase Inversion

Set the phase of tweeter, mid range, and woofer output.

Check **Phase Inversion** to shift the phase 180 degrees.

\*1 Only when "LPF FREQ"/"HPF FREQ" (Band Pass) is set to a mode other than "Through" in **X'over**.

\*2 Only when "FREQ" (Low Pass) is set to a mode other than "Through" in **X'over**.

#### NOTE

- For how to switch to the 3-way speaker system, see **3-way speaker system setup (P.87)**. Connecting 3-way speakers with the 2-way mode selected can break the speakers.

## Controlling General Audio

- 1 Press the **MENU** button.
  - Popup menu appears.
- 2 Touch **Audio**.
  - Audio screen appears.
- 3 Touch **Fader / Balance**.

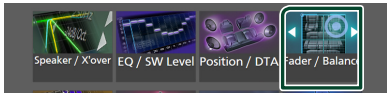

- 4 Set each parameter as follows.

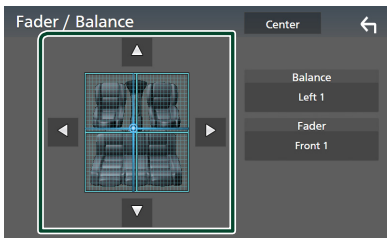

### ■ Fader / Balance

Adjust the volume balance around the touched area.

◀ and ▶ adjust the right and left volume balance.

▲ and ▼ adjust the front and rear volume balance.

### ■ Center

Clear the adjustment.

### NOTE

- When the 3-way speaker system is selected, "Fader" adjustment is disabled.

## Equalizer Control

You can adjust equalizer by selecting the optimized setting for each category.

- 1 Press the **MENU** button.
  - Popup menu appears.
- 2 Touch **Audio**.
  - Audio screen appears.
- 3 Touch **EQ / SW Level**.



- 4 Touch the screen and set the **Graphic Equalizer** as desired.

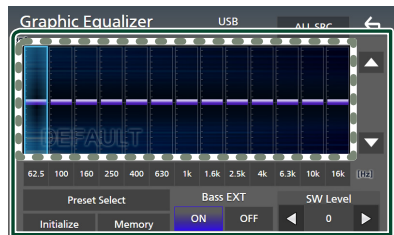

### ■ Gain level (area in dotted frame)

Adjust the gain level by touching each frequency bar.

You can select a frequency bar and adjust its level by ▲, ▼.

### ■ Preset Select

Display the screen for selecting the preset equalizer curve. **(P.91)**

### ■ Memory

Saves the adjusted equalizer curve as "User1" to "User4". **(P.91)**

### ■ Initialize

Initialize (flatten) the current EQ curve.

### ■ ALL SRC

Apply the adjusted equalizer curve to all sources. Touch **ALL SRC** and then touch **OK** on the confirmation screen.

### ■ Bass EXT (Bass Extend Settings)

When turned on, the frequencies lower than 62.5 Hz is set to the same gain level (62.5 Hz).

### ■ SW Level

Adjust the subwoofer volume. This setting is not available when Subwoofer is set to "None". See **Speaker / X'over setup (P.88)**.

### 📄 Recall the EQ curve

- 1 Touch **Preset Select**.
- 2 Select an EQ curve.

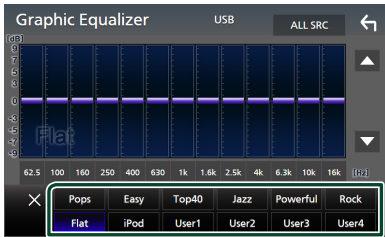

#### NOTE

- **iPod** is available for the iPod and Apple CarPlay sources and it is connected via USB.
- **iPod** is also available for the Apple CarPlay source that is connected wirelessly.

### 📄 Save the EQ curve

- 1 Adjust the EQ curve.
- 2 Touch **Memory**.
- 3 Select where to save.

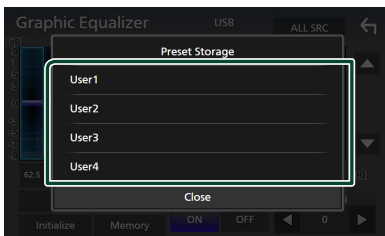

## Volume Offset

Finely adjust the volume of the current source to minimize the difference in volume between different sources.

- 1 Press the **MENU** button.
  - Popup menu appears.
- 2 Touch **Audio**.
  - Audio screen appears.
- 3 Touch **Volume Offset**.

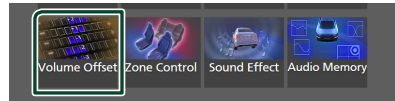

- 4 Touch **+ or -** to adjust the level.



### ■ Initialize

Returns to the initial settings.

Touch **Initialize** and then touch **YES** on the confirmation screen.

#### NOTE

- If you have increased the volume first, then reduce the volume using "Volume Offset". Switching the current source to another source suddenly may output extremely loud sound.

## Zone Control

You can select different sources for front and rear positions in the vehicle.

**1 Press the MENU button.**

➤ Popup menu appears.

**2 Touch Audio.**

➤ Audio screen appears.

**3 Touch Zone Control.**

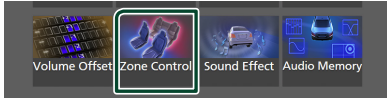

➤ Zone Control screen appears.

**4 Touch Zone Select.**

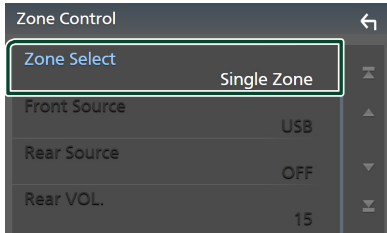

**5 Touch Dual Zone.**

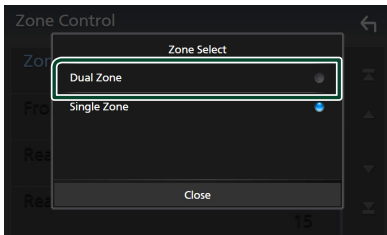

**6 Set each source as follows.**

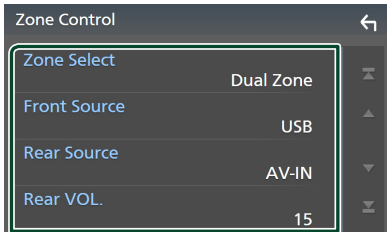

**■ Zone Select**

Touch **Single Zone** to turn off the dual zone function.

**■ Front Source, Rear Source**

Select an audio source for each.

Rear Source;

“AV-IN”/“DISC”/“iPod”/“USB”/“OFF”

**■ Rear VOL.**

Adjust the rear source volume.

### NOTE

- When the rear source is switched, the audio source that is output at the AV OUTPUT terminal is also switched to the same source.
- When the dual zone function is set to on, the following functions are not available.
  - Output from the subwoofer
  - Subwoofer Level/Bass Boost (P.93)
  - Equalizer Control/Sound Effect/Listening Position (P.90, 93, 94)
  - Speaker Setup (P.88)
  - High-resolution Sound Source File Playback
- When the dual zone is selected and audio source other than “OFF” is selected as Rear Source, the speaker system cannot be switched.
- You cannot select AV-IN if the AV-IN input terminal is used for camera.

### Rear Source

- You cannot select iPod if it is connected via Bluetooth.
- If you select USB, iPod, DISC (Music CD/Disc media), Bluetooth audio, Radio or HD Radio as the Front Source, you cannot select USB, iPod or DISC (Music CD/Disc media) as the Rear Source.
- If you select Wireless Mirroring, Apple CarPlay or Android Auto as the Front Source, you cannot select DISC (Music CD/Disc media), USB or iPod as the Rear Source.

## Sound Effect

You can set sound effects.

- 1 Press the **MENU** button.
  - Popup menu appears.
- 2 Touch **Audio**.
  - Audio screen appears.
- 3 Touch **Sound Effect**.

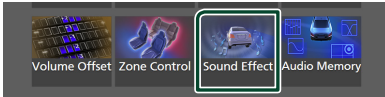

- 4 Set each parameter as follows.

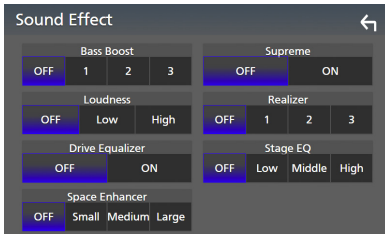

### ■ Bass Boost

Set the amount of bass boost "OFF"/"1"/"2"/"3".

### ■ Loudness

Set the amount of boost of low and high tones.

"OFF", "Low", "High"

### ■ Drive Equalizer

Reduces the driving noise by raising the bandwidth.

"OFF", "ON"

### ■ Space Enhancer

Select the feeling of sound space enhancement.

"OFF"/"Small"/"Medium"/"Large".

This setting is not available for the HD Radio tuner source.

### ■ Supreme

Turn ON/OFF the Supreme function.

Technology to extrapolate and supplement with proprietary algorithm, the high-frequency range that is cut off when encoding.

### ■ Realizer

Virtually make the sound more realistic using the Digital Signal Processor (DSP) system.

Select the level from "OFF"/"1"/"2"/"3".

### ■ Stage EQ

You can adjust the height of speakers virtually to suit your listening position.

"OFF"/"Low"/"Middle"/"High".

## Listening Position / DTA

Listening Position / DTA allows you to improve the sound field depending on the position of the seat you sit.

Listening Position / DTA allows you to set "Listening Position" and "Front Focus". You cannot set both at the same time.

- 1 Press the **MENU** button.
  - Pop up menu appears.
- 2 Touch **Audio**.
  - Audio screen appears.
- 3 Touch **Position / DTA**.



- Set up Listening Position (P.94)
- Set up Front Focus (P.94)

### Listening Position

Adjust the sound delay time so that the sounds from different speakers arrive at the listener sitting on the selected seat at the same time.

- 1 Touch **Listening Position** on the Position / DTA screen.
- 2 Select a listening position from **Front R** (Right front), **Front L** (Left front), **Front All** (All front), and **All**.

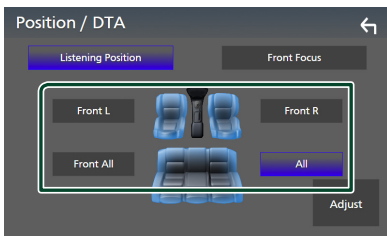

### Position DTA control

You can fine-adjust your listening position.

- 1 Touch **Adjust**.
- 2 Touch **Delay**.

- 3 Touch ◀ or ▶ to adjust the delay time of the selected speaker.

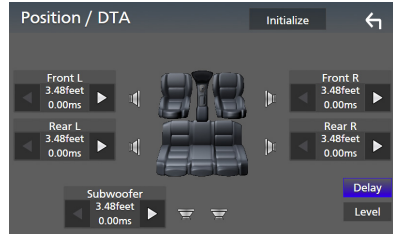

- 4 Touch **Level**.
- 5 Touch ◀ or ▶ to adjust the sound level of the selected speaker.



### NOTE

- To initialize the Delay and Level settings, touch **Initialize** and **YES** on the confirmation screen.

### Front Focus

You can focus the imaginary sound image on the front of the selected seat.

- 1 Touch **Front Focus** in the Position / DTA screen.
- 2 Select a front focus position.

For **Front All** and **All**, select Priority L or R depending on which side you want to put the imaginary sound image.

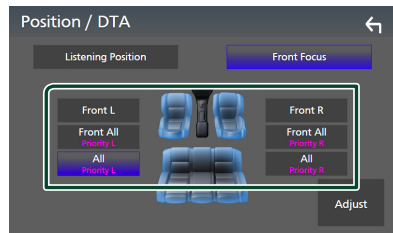

**NOTE**

- When the 3-way speaker system is selected, front focus feature is disabled.

**Front Focus fine adjustment**

- 1 Touch **Adjust**.
- 2 Touch **Delay**.
- 3 Set each parameter as follows.

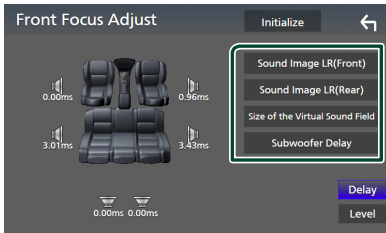
**Sound Image LR (Front)**

Focus the sound image on the front of front seats.

**Sound Image LR (Rear)**

Focus the sound image on the front of rear seats.

**Size of the Virtual Sound Field**

Adjust the size of sound image to meet your taste. If the sound image is shifted from the front, move it back by **Sound Image LR (Front)** or **Sound Image LR (Rear)**.

**Subwoofer Delay**

Adjust the delay time of subwoofer sound.

**4 Touch Level.**

- 5 Touch ◀ or ▶ to adjust the sound level of the selected speaker.

**NOTE**

- To initialize the Delay and Level settings, touch **Initialize** and **YES** on the confirmation screen.

**Audio Setup memory**

Audio Control settings can be memorized. The memorized settings can be recalled at any time.

- 1 Press the **MENU** button.
  - Popup menu appears.
- 2 Touch **Audio**.
  - Audio screen appears.
- 3 Touch **Audio Memory**.

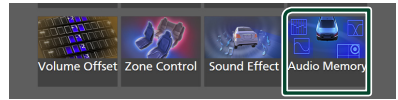
**SETUP Memory**

Lock or unlock the Audio SETUP Memory/Recall/Clear.

**Audio SETUP Memory**

Memorize the current audio settings.

- Fader / Balance, Speaker / X'over, Equalizer (User Preset, SW Level), Position / DTA, Sound Effect (**P.87**)

**Audio SETUP Recall**

Recall the memorized audio setting.

**Audio SETUP Clear**

Clear the Audio SETUP Memory and the currently memorized audio settings.

## Remote control

This unit can be operated using the remote control KNA-RCDV331 (optional accessory).

### ⚠ CAUTION

- Put the remote control in a place where it will not move during braking or other operations. A dangerous situation could result, if the remote control falls down and gets wedged under the pedals while driving.
- Do not leave the battery near fire or under direct sunlight. A fire, explosion or excessive heat generation may result.
- Do not recharge, short, break up or heat the battery or place it in an open fire. Such actions may cause the battery to leak fluid. If spilled fluid comes in contact with your eyes or on clothing, immediately rinse with water and consult a physician.
- Place the battery out of reach of children. In the unlikely event that a child swallows the battery, immediately consult a physician.

### Battery Installation

If the remote control operates only over shorter distances or does not operate at all, it is possible that the batteries are depleted.

In such instances, replace the both batteries with new ones.

- 1 Insert two "AAA"/"R03"-size batteries with the ⊕ and ⊖ poles aligned properly, following the illustration inside the case.

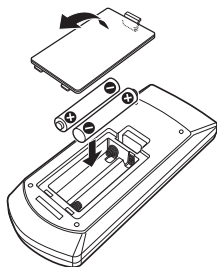

### Functions of the Remote control Buttons

#### ■ Switch the operation mode

The functions operated from the remote control differ depending on the position of the mode switch.

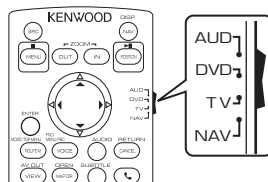

#### ■ AUD mode

Switch to this mode when controlling a selected source or tuner source, etc.

#### ■ DVD mode

Switch to this mode when playing a disc media including DVD, VCD, and CD.

#### ■ TV mode/NAV mode

Not used.

#### NOTE

- When controlling a player that is not integrated in the unit, select "AUD" mode.

#### ■ Direct search mode

Using the remote control, you can jump directly to the desired file, track, chapter, etc. by entering the number corresponding to the content.

#### NOTE

- This operation cannot be performed for the USB device and iPod.

- 1 Press the #BS button several times until the desired content appears.

The available contents are different depending on the source type.



### ■ DVD

Title number/Chapter number

### ■ VCD 1.X and 2.X (PBC OFF)

Track number

### ■ VCD 2.X (PBC ON)

Scene number/Track number

### ■ Music CD

Track number

### ■ Radio

(DDX9707S / DMX9707S)

Frequency value

### ■ HD Radio tuner

(DDX9907XR / DMX957XR / DMX907S)

Frequency value/Channel number

### ■ SiriusXM

Channel number

**2** Enter the number of the content you want to play using the numeric keypad.

**3** For DVD, VCD or music CD, press the **ENTER** button.

For radio, press the ◀ or ▶/◀◀ or ▶▶▶ button.

➤ The content corresponding to the number you entered is played.

## Basic Operation

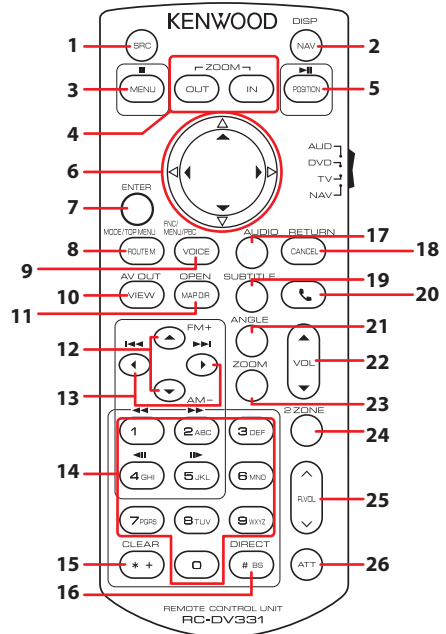

	Key Name	Mode switch	Function
1	SRC	AUD, DVD	Switches to the source to be played. In hands-free mode, hangs up the phone.
2	NAV	–	Displays the APP (Apple CarPlay/Android Auto/Wireless Mirroring) screen.
3	MENU	DVD	Stops playing and memorizes the last point where the disc stopped. The last point is deleted by pressing twice.
4	OUT, IN	–	Not used.
5	POSITION	AUD, DVD	Pauses the track or file, and resumes playing by pressing twice. For the Radio (DDX9707S / DMX9707S only) and HD Radio (DDX9907XR / DMX957XR / DMX907S only) sources in AUD mode, switches the seek mode.
6	Cursor Key	DVD	Moves the cursor in the DVD menu.
7	ENTER	–	Performs the selected function.
8	ROUTE M	AUD DVD	Screen mode changes each time you press this key during video playback. Returns to the DVD top menu.
9	VOICE	AUD DVD	Displays the control screen of current source. (USB, DISC) Displays the DVD menu. Turns the playback control on or off while playing VCD.
10	VIEW	AUD, DVD	Switches the AV source to be output.
11	MAP DIR	AUD, DVD	Switches the display angle each time it is pressed. (DDX9907XR / DDX9707S / DMX957XR only)

## Remote control

	Key Name	Mode switch	Function
12	▲/▼	AUD, DVD	Selects the folder to be played. For the Radio (DDX9707S / DMX9707S only) and HD Radio (DDX9907XR / DMX957XR / DMX907S only) sources in AUD mode, selects FM/AM band to be received. For the SiriusXM source in AUD mode, selects the band to be received. For the DVD source in DVD mode, selects the title to be played.
13	◀/▶	AUD, DVD	Selects the track or file to be played. For the Radio (DDX9707S / DMX9707S only) and HD Radio (DDX9907XR / DMX957XR / DMX907S only), and SiriusXM sources in AUD mode, switches to broadcast stations received by the unit. For the DVD/VCD source in DVD mode, selects the chapter/scene/track to be played.
14	Numeric Keypad	AUD	Allows you to enter the number to search in the direct search mode. For details on the direct search mode, see <b>Direct search mode (P.96)</b> . For the Radio (DDX9707S / DMX9707S only) and HD Radio (DDX9907XR / DMX957XR / DMX907S only), and SiriusXM sources, allows you to enter the preset number. <ul style="list-style-type: none"> <li>• If the preset number is one digit, press the number.</li> <li>• If the preset number is two digits, press continuously the numbers within 3 seconds.</li> <li>• Pressing ◀ ▶ within 3 seconds allows you to determine the preset number of one digit.</li> </ul> For the VCD source, allows you to enter the track number when Playback control (PBC) is on and the menu is displayed. <ul style="list-style-type: none"> <li>• If the track number is one digit, press the number.</li> <li>• If the track number is two digits, switch to the direct search mode to enter the numbers.</li> </ul>
		DVD	For the DVD source in DVD mode, allows you to enter the number to search in the direct search mode. For details on the direct search mode, see <b>Direct search mode (P.96)</b> . For the DVD source in DVD mode, change the play mode as follows: <ul style="list-style-type: none"> <li>• Press <b>1 2</b> to fast forward/backward.</li> <li>• Press <b>4 5</b> to slow forward/backward. Switches the slow playback speed each time you press this key.</li> </ul>
15	* +	DVD	Deletes a character while in direct search mode.
16	# BS	AUD, DVD	Switches to the direct search mode. For details on the direct search mode, see <b>Direct search mode (P.96)</b> .
17	AUDIO	DVD	Switches the voice language each time you press this key.
18	CANCEL	DVD	Cancels the direct search mode and returns to the previous screen. For the VCD source in DVD mode, returns to the previous scene.* *Only when Playback control (PBC) is on.
19	SUBTITLE	DVD	Switches the subtitle language.
20		–	When a call comes in, answers the call.
21	ANGLE	DVD	Switches the picture angle each time you press this key.
22	VOL ▲▼	–	Adjusts the volume.
23	ZOOM	DVD	Switches the zoom ratio (2, 3, 4, Off) each time you press this key.
24	2 ZONE	AUD, DVD	Switches the Dual Zone function on and off.
25	R.VOL ^/▼	–	Adjusts volume at rear when the Dual Zone function is on.
26	ATT	–	Lowers the volume when pressed once. Restores the previous volume when pressed twice.

# Connection/Installation

This section is for the professional installer. For safety's sake, leave wiring and mounting to professionals. Consult the car audio dealer.

## Before Installation

Before installation of this unit, please note the following precautions.

### ▲ WARNINGS

- If you connect the ignition wire (red) and the battery wire (yellow) to the car chassis (ground), you may cause a short circuit, that in turn may start a fire. Always connect those wires to the power source running through the fuse box.
- Do not cut out the fuse from the ignition wire (red) and the battery wire (yellow). The power supply must be connected to the wires via the fuse.

### ▲ CAUTION

- Install this unit in the console of your vehicle. Do not touch the metal part of this unit during and shortly after the use of the unit. Metal part such as the heat sink and enclosure become hot.

### NOTE

- Mounting and wiring this product requires skills and experience. For best safety, leave the mounting and wiring work to professionals.
- Make sure to ground the unit to a negative 12V DC power supply.
- Do not install the unit in a spot exposed to direct sunlight or excessive heat or humidity. Also avoid places with too much dust or the possibility of water splashing.
- Do not use your own screws. Use only the screws provided. If you use the wrong screws, you could damage the unit.
- If the power is not turned ON ("There is an error in the speaker wiring. Please check the connections." is displayed), the speaker wire may have a short-circuit or touched the chassis of the vehicle and the protection function may

have been activated. Therefore, the speaker wire should be checked.

- If your car's ignition does not have an ACC position, connect the ignition wires to a power source that can be turned on and off with the ignition key. If you connect the ignition wire to a power source with a constant voltage supply, such as with battery wires, the battery may be drained.
- If the console has a lid, make sure to install the unit so that the front panel will not hit the lid when closing and opening.
- If the fuse blows, first make sure the wires aren't touching to cause a short circuit, then replace the old fuse with one with the same rating.
- Insulate unconnected wires with vinyl tape or other similar material. To prevent a short circuit, do not remove the caps on the ends of the unconnected wires or the terminals.
- Connect the speaker wires correctly to the terminals to which they correspond. The unit may be damaged or fail to work if you share the ⊖ wires or ground them to any metal part in the car.
- When only two speakers are being connected to the system, connect the connectors either to both the front output terminals or to both the rear output terminals (do not mix front and rear). For example, if you connect the ⊕ connector of the left speaker to a front output terminal, do not connect the ⊖ connector to a rear output terminal.
- After the unit is installed, check whether the brake lamps, blinkers, wipers, etc. on the car are working properly.
- Mount the unit so that the mounting angle is 30° or less.
- This unit has the cooling fan to decrease the internal temperature. Do not mount the unit in a place where the cooling fan of the unit is blocked. Blocking these openings will inhibit the cooling of the internal temperature and result in malfunction.

## Connection/Installation

### In case of DDX9907XR

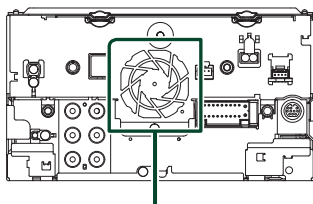

Cooling fan

- Do not press hard on the panel surface when installing the unit to the vehicle. Otherwise scars, damage, or failure may result.
- Reception may drop if there are metal objects near the Bluetooth antenna.

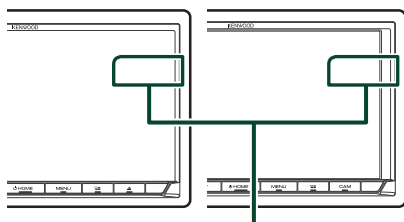

Bluetooth antenna unit

### Supplied accessories for installation

①		x1
②	(Black 1 m)	x1
③	(Gray 1 m)	x1
④	(3 m)	x1
⑤		x2

⑥	(M5 x 8 mm)	x6
⑦	(M5 x 8 mm)	x6
⑧		x1
⑨	(3.5 m)	x1
⑩		x1
⑪ <sup>[1]</sup>		x1

<sup>[1]</sup> DDX9907XR / DMX907S / DMX957XR only

### Installation procedure

- 1) To prevent a short circuit, remove the key from the ignition and disconnect the  $\ominus$  terminal of the battery.
- 2) Make the proper input and output wire connections for each unit.
- 3) Connect the speaker wires of the wiring harness.
- 4) Connect the wiring harness wires in the following order; ground, battery, ignition.
- 5) Connect the wiring harness connector to the unit.
- 6) Install the unit in your car.
- 7) Reconnect the  $\ominus$  terminal of the battery.
- 8) Perform the Initial Setup.  
See **Initial SETUP (P.10)**.

## Installing the unit

### Non-Japanese cars

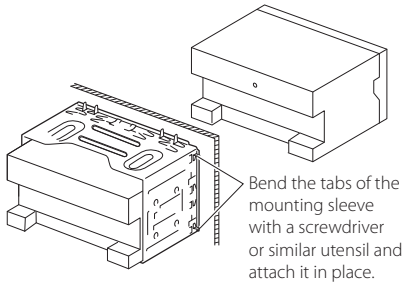

### Japanese cars

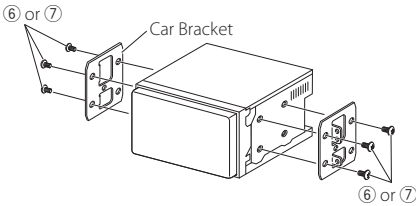

#### NOTE

- Make sure that the unit is installed securely in place. If the unit is unstable, it may malfunction (eg, the sound may skip).

### Trim plate

- 1) Attach accessory ⑧ to the unit.

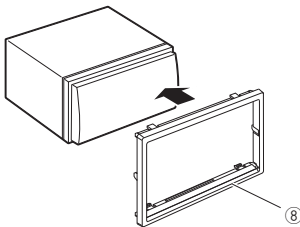

### GPS antenna

GPS antenna is installed inside of the car. It should be installed as horizontally as possible to allow easy reception of the GPS satellite signals.

To mount the GPS antenna inside your vehicle:

- 1) Clean your dashboard or other surface.
- 2) Remove the separator of the metal plate (accessory ⑩).
- 3) Press the metal plate (accessory ⑩) down firmly on your dashboard or other mounting surface. You can bend the metal plate (accessory ⑩) to conform to a curved surface, if necessary.
- 4) Remove the separator of the GPS antenna (accessory ⑨), and stick the antenna to the metal plate (accessory ⑩).

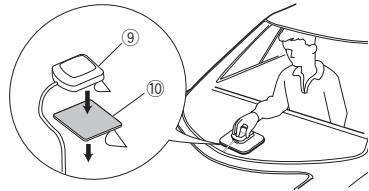

#### NOTE

- Use the supplied GPS antenna. Using the GPS antenna other than the supplied one may cause a drop in positioning accuracy.
- Depending on the type of car, reception of the GPS satellite signals might not be possible with an inside installation.
- Please install this GPS antenna in an area away from any antennas that are used with CB radios or satellite televisions.
- The GPS antenna should be installed at a position that is spaced at least 12 inch (30 cm) from cellular phone or other transmitting antennas. Signals from the GPS satellite may be interfered with by these types of communication.
- Painting the GPS antenna with (metallic) paint may cause a drop in performance.

**Microphone unit**

- 1) Check the installation position of the microphone (accessory ④).
- 2) Clean the installation surface.
- 3) Remove the separator of the microphone (accessory ④), and stick the microphone to the place shown below.
- 4) Wire the microphone cable up to the unit with it secured at several positions using tape or other desired method.
- 5) Adjust the direction of the microphone (accessory ④) to the driver.

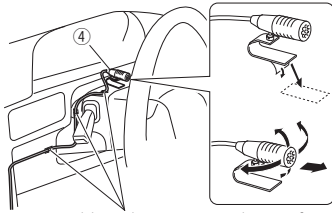

Fix a cable with a commercial item of tape.

**Removing the trim plate**

- 1) Engage the catch pins on the extraction key (accessory ⑤) and remove the two locks on the lower level.  
Lower the trim plate (accessory ⑧) and pull it forward as shown in the figure.

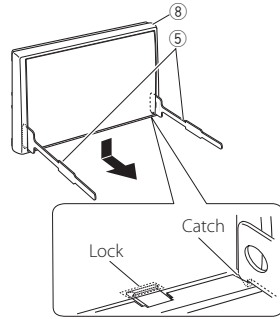

**NOTE**

- The trim plate can be removed from the top side in the same manner.

- 2) When the lower level is removed, remove the upper two locations.

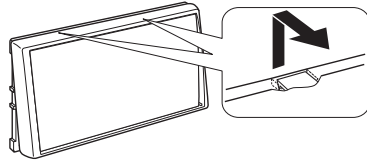

## ■ Removing the unit

- 1) Remove the trim plate. (P.102)
- 2) Insert the two extraction key (accessory ⑤) deeply into the slots on each side, as shown.

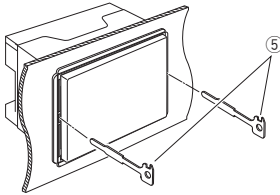

- 3) Lower the extraction key toward the bottom, and pull out the unit halfway while pressing towards the inside.

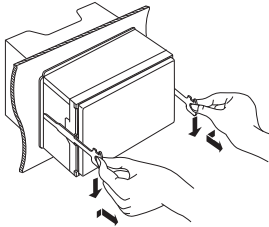

### NOTE

- Be careful to avoid injury from the catch pins on the extraction key.

- 4) Pull the unit all the way out with your hands, being careful not to drop it.

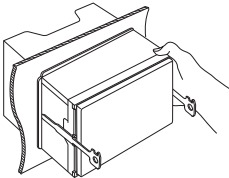

## Connecting wires to terminals

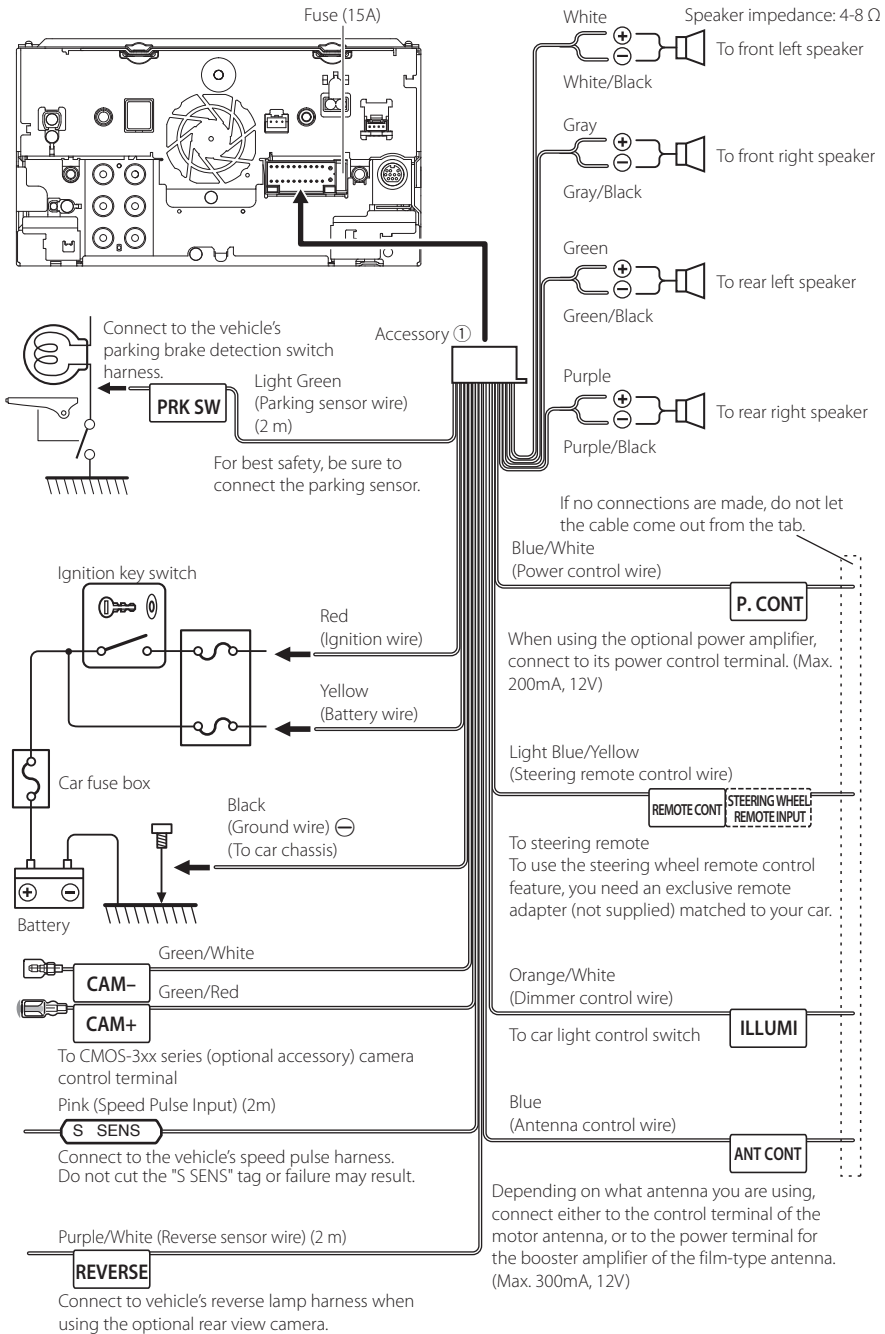



### 3-way speaker system setup

● DDX9907XR / DMX957XR / DMX907S

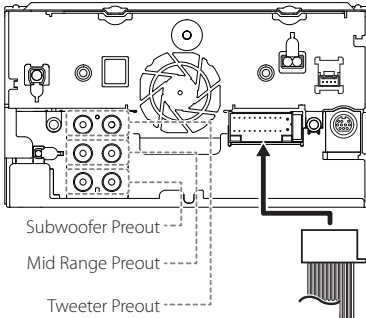

When connecting to an external amplifier, connect its ground wire to the car's chassis to avoid damaging the unit.

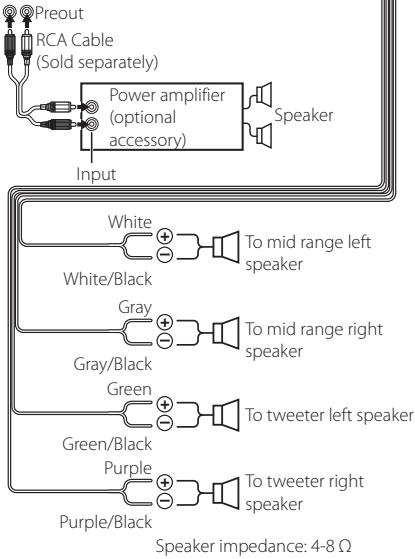

#### NOTE

- For speaker system setup, see **3-way speaker system setup (P.87)**.
- For speaker setup and crossover setup, see **Speaker / X'over setup (P.88)**.
- For how to connect speaker wires to terminals other than speaker terminals and Preout terminals, see **Connecting the system and external components (P.105)** and **Connecting wires to terminals (P.104)**.

### Connecting the system and external components

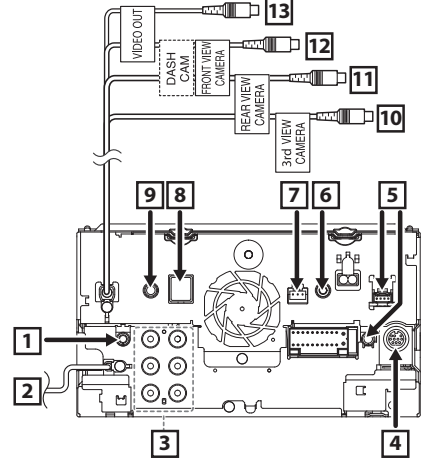

<b>1</b>	AV Audio output (ø3.5 mini jack)
<b>2</b>	FM/AM antenna input 
<b>3</b>	When connecting to an external amplifier, connect its ground wire to the car's chassis to avoid damaging the unit. 
<b>4</b>	SiriusXM Connect Vehicle Tuner connector For more information on how to install the SiriusXM Connect Vehicle tuner, consult the installation guide included with the tuner.
<b>5</b>	iDataLink connector
<b>6</b>	This jack accepts either AV-IN or camera input. For more information, see <b>To set up the camera assignment settings (P.77)</b> . <b>DDX9907XR / DMX957XR / DMX907S :</b> Accessory : Mini plug to RCA cable*1 
	or CA-C3AV (optional accessory) <b>DDX9707S / DMX9707S :</b> CA-C3AV (optional accessory)

## Connection/Installation

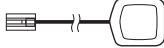
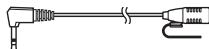
7	Dashboard camera interface Connect a Dashboard Camera DRV-N520 (optional accessory). <b>(P.108)</b>
8	Accessory ⑨: GPS Antenna Use the supplied GPS antenna. Using the GPS antenna other than the supplied one may cause a drop in positioning accuracy. 
9	Accessory ④: Bluetooth Microphone 
10	3rd view camera input (Yellow). See <b>To set up the camera assignment settings (P.77)</b> .
11	Rear view camera input (Yellow) *2
12	Front view camera/Dashboard camera input (Yellow). See <b>To set up the camera assignment settings (P.77)</b> . *3
13	VIDEO Output (Yellow)

- \*1 Connecting Mini plug to RCA cable to AV-IN terminal enables you to use cameras only. If you connect CA-C3AV (optional accessory), AV-IN (for visual) or the camera is available.
- \*2 Connect an HD camera to Rear view camera input terminal to use HD video. (DDX9907XR / DMX957XR only)
- \*3 Connect an HD camera to Front view camera/Dashboard camera input terminal to use HD video. (DDX9907XR / DMX957XR only)

## Connecting a USB device

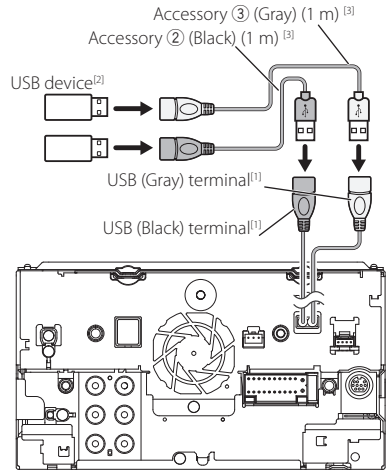

[1] USB maximum power supply current :DC 5 V  
1.5 A

[2] Sold separately

[3] See **Securing the USB extension cable (P.107)**.

## Securing the USB extension cable

Secure the USB extension cable with insulating tape or the like so that its connectors are not disconnected.

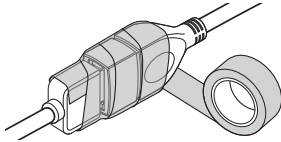

## Connecting an iPod/iPhone

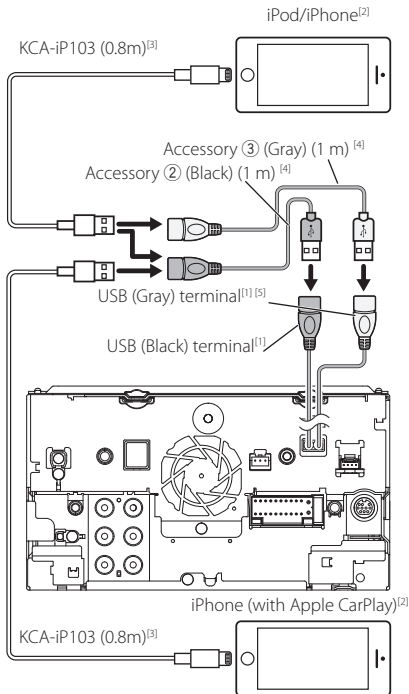

<sup>[1]</sup> USB maximum power supply current :DC 5 V  
 1.5 A

<sup>[2]</sup> Sold separately

<sup>[3]</sup> Optional accessory

<sup>[4]</sup> See **Securing the USB extension cable (P.107)**.

<sup>[5]</sup> USB (Gray) terminal does not support USB Mirroring.

## Connecting an Android smartphone

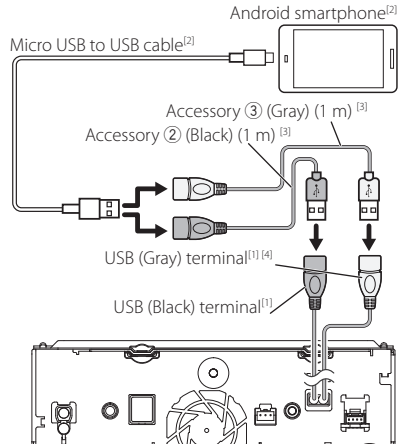

<sup>[1]</sup> USB maximum power supply current :DC 5 V  
 1.5 A

<sup>[2]</sup> Sold separately

<sup>[3]</sup> See **Securing the USB extension cable (P.107)**.

<sup>[4]</sup> USB (Gray) terminal does not support USB Mirroring.

## Connecting the camera

Left side view camera and  
Right side view camera [2]

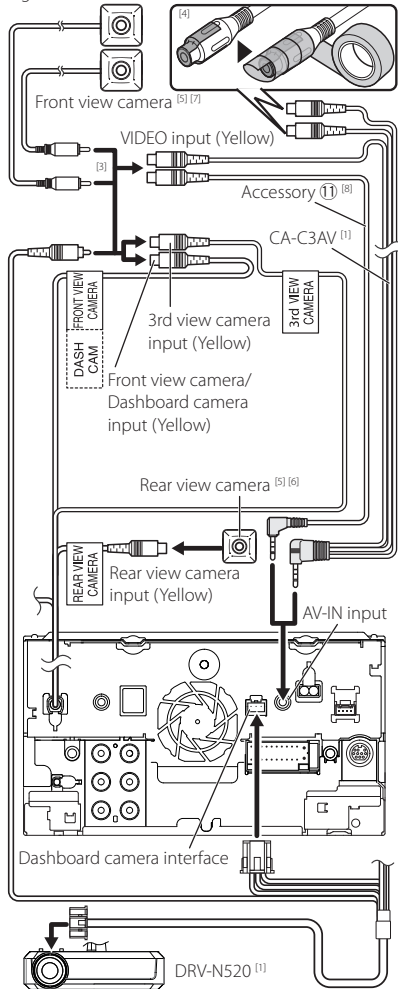

[5] CMOS-3xx series (optional accessory) or commercially available camera.

[6] For HD video, an HD camera is also used as Rear view camera. (DDX9907XR / DMX957XR only)

[7] For HD video, an HD camera is also used as Front view camera. (DDX9907XR / DMX957XR only)

[8] DDX9907XR / DMX957XR / DMX907S only

[1] Optional accessory

[2] Sold separately

[3] Up to 3 cameras of Dashboard camera, Front view camera, Left side view camera and Right side view camera can be connected. For more information, see **Camera Assignment Settings (P.76)**.

[4] Insulate audio input terminals of a CA-C3AV (optional accessory) when connecting to the Camera.

# Troubleshooting

## Problems and Solutions

If any trouble occurs, first check the following table for possible problems.

### NOTE

- Some functions of this unit may be disabled by some settings made on this unit.
- What might seem to be a malfunction in your unit may just be the result of slight misoperation or miswiring.

### About settings

- **Cannot set up the subwoofer.**
- **Cannot set up subwoofer phase.**
- **No output from the subwoofer.**
- **Cannot set up the low pass filter.**
- **Cannot set up the high pass filter.**

Subwoofer is not set to on.

- Set the subwoofer to on. See **Speaker / X'over setup (P.88)**.

The dual zone function is enabled.

- Set the dual zone function to off. See **Zone Control (P.92)**.

- **Cannot select the output destination of the subsource in the dual zone.**
- **Cannot adjust the volume of the rear speakers.**

The dual zone function is disabled.

- Set the dual zone function to on. See **Zone Control (P.92)**.

- **Cannot set up the equalizer.**
- **Cannot set up the crossover network.**

The dual zone function is enabled.

- Set the dual zone function to off. See **Zone Control (P.92)**.

### About audio operations

#### Radio reception is poor.

The car antenna is not extended.

- Pull out the antenna all the way.

The antenna control wire is not connected.

- Connect the wire correctly. See **Connecting the system and external components (P.105)**.

#### Cannot select a folder.

The random play function is enabled.

- Turn off the random function.

#### Cannot perform repeat play during VCD playback.

The PBC function is enabled.

- Turn off the PBC function.

#### The specified disc does not play, but another one plays instead.

The disc is quite dirty.

- Clean the disc. See **Precautions on handling discs (P.6)**.

The disc is severely scratched.

- Try another disc instead.

#### The sound skips when an audio file is being played.

The disc is scratched or dirty.

- Clean the disc. See **Precautions on handling discs (P.6)**.

The recording condition is bad.

- Record the file again or use another disc.

#### No sound while using Mirroring for KENWOOD application.

- Make sure the smartphone and the unit is connected via Bluetooth and connected over A2DP/SPP. **(P.29)**

- Raise the volume on your smartphone.

Some application does not support Mirroring for KENWOOD application playback. (Apple Music App does not support playback using Mirroring for KENWOOD application.)

- Try another music application.

#### No sound while using "iPod" source or "Bluetooth" source.

- Make sure you stop broadcast on iPhone's screen recording function after you disconnect from mirroring operations.

#### Cannot operate Mirroring for KENWOOD application with touch panel operation.

Available functions may differ from the ones operated on the smartphone.

Depending on the connected smartphone, some functions do not work on this unit.

Depending on the operating system (OS) of the connected smartphone, some functions do not work on this unit.

- Change the smartphone to compatible device. See **USB Mirroring Operation (P.29)**.

#### The unit does not respond when you try to perform a operation during USB mirroring.

- Unplug the smartphone from the USB (Black) terminal, then reattach the smartphone again.

### Others

#### The Touch Sensor Tone doesn't sound.

The preout jack is being used.

- The Touch Sensor Tone cannot be output from the preout jack.

### Error Messages

When you fail to operate the unit correctly, the cause of the failure appears as the message on the screen.

---

#### There is an error in the speaker wiring. Please check the connections.

Protective circuit has been activated because a speaker cord has shorted or it has come in contact with the car chassis.

- Wire or insulate the speaker cord as appropriate and turn the power off and on again.

---

#### Hot Error

When the internal temperature of this unit rises to 60°C or more, the protection circuit is activated and you may not be able to operate the unit.

- Use the unit again after reducing the temperature of the unit.

---

#### Mecha Error

The disc player is malfunctioning.

- Eject the disc and try inserting it again. Contact the KENWOOD dealer if this indicator continues blinking or the disc cannot be ejected.

---

#### Disc Error

An unplayable disc is inserted.

- Change the disc. See **Playable Media and Files (P.112)**.

---

#### Read Error

The disc is quite dirty.

- Clean the disc. See **Precautions on handling discs (P.6)**.

Disc is upside down.

- Load the disc with the labeled side up.

---

#### Region Code Error

The disc you wanted to play has a region code that cannot be played with this unit.

- See **Region Codes in the World (P.114)** or try another disc.

---

#### Error 07–67

The unit is not operating correctly due to some reason or other.

- Turn the power off and on again. If the “Error 07–67” message does not disappear, contact your nearest KENWOOD dealer.

---

#### No Device (USB device)

The USB device is selected as a source although no USB device is connected.

- Change the source to any source other than USB/iPod. Connect a USB device, and change the source to USB again.

---

#### Disconnected (iPod, Bluetooth audio player)

The iPod/Bluetooth audio player is selected as a source although no iPod/Bluetooth audio player is connected.

- Change the source to any source other than iPod/Bluetooth. Connect an iPod/Bluetooth audio player, and change the source to iPod/Bluetooth again.

---

#### No Media file

The connected USB device contains no playable audio file. Media was played that doesn't have data recorded that the unit can play.

- See **Playable Media and Files (P.112)** and try another USB device.

The USB device which contains no playable audio file is selected.

- Switch USB devices. See **USB DEVICE CHANGE (P.38)**.

---

#### USB device over current status detected.

The connected USB device is rated a current capacity higher than the allowable limit.

- Check the USB device. Some trouble may have occurred to the connected USB device.
- Change the source to any source other than USB. Remove the USB device.

## SiriusXM

### Check Tuner

A SiriusXM tuner is not connected to this unit.

- Verify that the SiriusXM Connect Vehicle Tuner cable is securely connected to the radio.

**Subscription Updated - Press Return To Continue**  
The SiriusXM subscription has been renewed.

- Touching **Return** on the popup screen will clear the message.

### SXM Chan Unavailable

The currently selected channel is unavailable.

- Visit [www.siriusxm.com](http://www.siriusxm.com) for more information about the SiriusXM channel lineup.

### SXM Ch Unsubscribed

The currently selected channel is not subscribed to.

- In the U.S.A., visit [www.siriusxm.com](http://www.siriusxm.com) or call 1-866-635-2349 if you have questions about your subscription package or would like to subscribe to this channel.
- In Canada, visit [www.siriusxm.ca](http://www.siriusxm.ca) or call 1-877-438-9677.

### SXM Check Antenna

No antenna is connected to the SiriusXM tuner.

- Check that an antenna is connected to the SiriusXM tuner. Check antenna for damages.

### SXM No Signal

No SiriusXM radio signal is received.

- Verify that your vehicle is outdoors with a clear view of the sky.

### Channel Locked

The selected channel has been locked by the parental controls.

- Enter the unlock code when you are asked. See **Parental Control (P.59)**.

### Incorrect Pass Code entered

The selected channel is a mature or parental lock channel, and locked by the parental lock or user lock code.

- Enter the correct lock code.

## Apple CarPlay

**The GPS antenna must be connected to use Apple CarPlay wirelessly. Please verify the proper connections or plug in by USB to use Apple CarPlay.**

The GPS antenna is not connected when the Apple CarPlay is started by connecting wirelessly or when the iPhone compatible with wireless Apple CarPlay is registered in **Apple CarPlay Device List**.

- Check the connection of the GPS antenna or plug in over USB to use Apple CarPlay.

**The speed sensor and the GPS antenna must be connected to use Apple CarPlay wirelessly. Please verify the proper connections or plug in by USB to use Apple CarPlay.**

The speed pulse is not detected and the GPS antenna is not connected when the Apple CarPlay is started by connecting wirelessly or when the iPhone compatible with wireless Apple CarPlay is registered in **Apple CarPlay Device List**.

- Check the connection of the speed pulse and the GPS antenna or plug in over USB to use Apple CarPlay.

# Appendix

## Playable Media and Files

You can play various kinds of media and files on this unit.

### List of playable discs (DDX9907XR / DDX9707S)

Disc types / Standard		Support	Remark
DVD	DVD Video	○	
	DVD Audio	×	
	DVD-VR	×	
	DVD-R*1	○	<ul style="list-style-type: none"> <li>• MP3 / WMA / AAC / WAV / FLAC / Vorbis / MPEG1 / MPEG2 / MPEG4 / H.264 / WMV / MKV playback</li> <li>• Multi-border/Multisession playback (Playback depends on authoring conditions)</li> </ul>
	DVD-RW	○	
	DVD+R	○	
	DVD+RW	○	
	DVD-R DL (Dual layer)	○	Only video format
	DVD+R DL (Double layer)	○	
	DVD-RAM	×	
CD	Music CD*1	○	
	CD-ROM	○	<ul style="list-style-type: none"> <li>• MP3 / WMA / AAC / WAV / FLAC / Vorbis playback</li> </ul>
	CD-R	○	<ul style="list-style-type: none"> <li>• Multisession is supported.</li> </ul>
	CD-RW	○	<ul style="list-style-type: none"> <li>• Packet write is not supported.</li> </ul>
	DTS-CD	×	
	Video CD (VCD)	○	
	Super video CD	×	
	Photo CD	×	
	CD-EXTRA	△	Only music CD session can be played.
	HDCD	△	Normal music CD sound quality
	CCCD	×	
Others	Dualdisc	×	
	Super audio CD	△	Only CD layer can be played.

○ : Playback is possible.

△ : Playback is partly possible.

×

\*1 Incompatible with 8 cm (3 inch) discs.

### Use of DualDisc

When playing a "DualDisc" on this unit, the surface of the disc that is not played may be scratched while the disc is inserted or ejected. Since the music CD surface does not conform to the CD standard, playback may be impossible.

(A "DualDisc" is a disc with one surface containing DVD standard signals and the other surface containing music CD signals.)

### About disc format

The disc format should be the one of the following.

- ISO 9660 Level 1, 2
- Joliet
- Romeo
- Long file name



## About files

The following audio and video files are supported.

### ■ Playable Audio files

	Format	Bit rate	Sampling frequency	Bit count
AAC-LC (.m4a)	MPEG-2/MPEG-4 AAC LC HE-AAC(V1,V2)	8 – 320kbps, VBR	16 – 48 kHz	16 bit
MP3 (.mp3)	MPEG-1/MPEG-2 Audio Layer 3	8 – 320kbps, VBR	16 – 48 kHz	16 bit
WMA (.wma)	Windows Media Audio Standard L3 profile (Version 7,8,9)	8 – 320kbps	16 – 48 kHz	16 bit
Linear PCM (WAVE) (.wav)	RIFF waveform Audio Format	–	16 – 48 kHz (Disc), 16 – 192 kHz (USB)	16 bit/24 bit
FLAC (.flac)	flac	–	16 – 48 kHz (Disc), 16 – 192 kHz (USB)	16 bit/24 bit
Vorbis (.ogg)	vorbis	–	16 – 48 kHz	16 bit

- If music of normal CD and other playback systems are recorded in the same disc, only the playback system recorded at the first setout is played.
- WMA and AAC files with DRM cannot be played.
- Although the audio files complies with the standards listed above, they may not be played depending on the types or conditions of media or device.
- This unit supports playback of High-Resolution Audio files.  
It is recommended that a car audio system should be configured with all High-Resolution Audio compatible products from player to speaker to enjoy its high quality sound.

### ■ Acceptable Video files

	Profile	Max. Picture size	Max. bit rate	Audio format
MPEG-1 (.mpg, .mpeg)	–	352 × 240, 352 × 288	1.5 Mbps	MPEG Audio Layer 2
MPEG-2 (.mpg, .mpeg)	MP@ML	720 × 480, 720 × 576	8 Mbps	MPEG Audio Layer 2
H.264/MPEG-4 AVC (.mp4, .m4v, .avi, .flv, .f4v)	Baseline Profile, Main Profile	1920 × 1080 (30 fps)	8 Mbps	MP3, AAC
MPEG-4 (.mp4, .avi)	Advanced Simple Profile	1920 × 1080 (30 fps)	8 Mbps	MP3, AAC
WMV (.wmv)	Main Profile	1920 × 1080 (30 fps)	8 Mbps	WMA
MKV (.mkv)	Video format follows H.264/MPEG-4 AVC, MPEG-4, WMV			MP3, AAC, WMA, Vorbis, FLAC

- This unit can only play back files which are smaller than 4 GB.

### ■ Limitation on structure of file and folder

	Disc media	USB device
Maximum number of folder layers	8	8
Maximum number of files (per folder)	999	999
Maximum number of folders (per folder)	5000	9999
Maximum number of folders (per device)	5000	Unlimited

- You can enter a folder name and file name with 254 (for Disc)/255 (for USB) or fewer single-byte characters.
- Files in the folder whose folder name begins with a dot (.) cannot be played.

## Region Codes in the World

The DVD players are given a region code according to the country or area it is marketed, as shown in the following map.

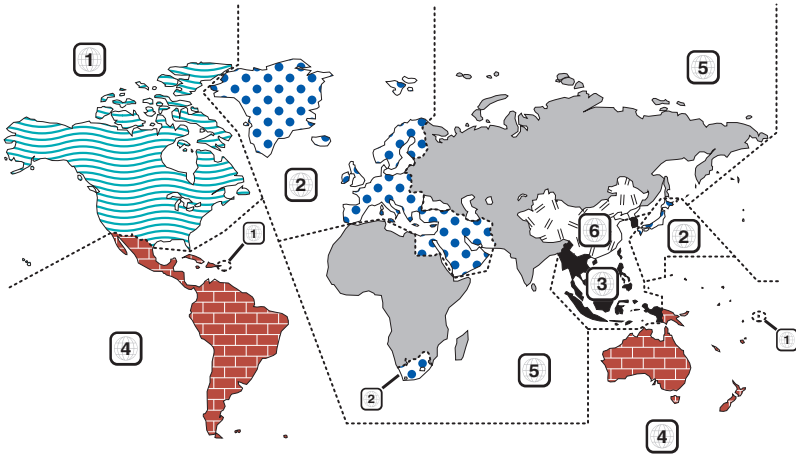

### ■ DVD disc marks



Indicates a region number. The discs with this mark can be played with any DVD player.



Indicates the number of audio languages recorded. Up to 8 languages can be recorded in a movie. You can select a favorite language.



Indicates the number of subtitled languages recorded. Up to 32 languages can be recorded.



If a DVD disc has scenes shot from multiple angles, you can select a favorite angle.



Indicates the type of screen for the image. The left mark indicates that a wide image picture (16:9) is displayed on a standard TV set screen (4:3) with a black band at both the top and bottom of the screen (letter box).

### ■ Operation regulatory marks

With this DVD, some functions of this unit such as the play function may be restricted depending on the location where the DVD is playing. In this case, the following marks will appear on the screen. For more information, refer to the disc manual.



### ■ Discs with limited period of use

Do not leave discs with a limited period of use in this unit. If you load an already expired disc, you may not be able to remove it from this unit.

## DVD Language Codes

Code	Language
aa	Afar
ab	Abkhazian
af	Afrikaans
am	Amharic
ar	Arabic
as	Assamese
ay	Aymara
az	Azerbaijani
ba	Bashkir
be	Byelorussian
bg	Bulgarian
bh	Bihari
bi	Bislama
bn	Bengali, Bangla
bo	Tibetan
br	Breton
ca	Catalan
co	Corsican
cs	Czech
cy	Welsh
da	Danish
de	German
dz	Bhutani
el	Greek
en	English
eo	Esperanto
es	Spanish
et	Estonian
eu	Basque
fa	Persian
fi	Finnish
fj	Fiji
fo	Faroese
fr	French
fy	Frisian
ga	Irish
gd	Scots Gaelic
gl	Galician
gn	Guarani
gu	Gujarati
ha	Hausa
he	Hebrew
hi	Hindi
hr	Croatian
hu	Hungarian
hy	Armenian

Code	Language
ia	Interlingua
ie	Interlingue
ik	Inupiak
id	Indonesian
is	Icelandic
it	Italian
ja	Japanese
jv	Javanese
ka	Georgian
kk	Kazakh
kl	Greenlandic
km	Cambodian
kn	Kannada
ko	Korean
ks	Kashmiri
ku	Kurdish
ky	Kirghiz
la	Latin
lb	Luxembourgish
ln	Lingala
lo	Laotian
lt	Lithuanian
lv	Latvian, Lettish
mg	Malagasy
mi	Maori
mk	Macedonian
ml	Malayalam
mn	Mongolian
mo	Moldavian
mr	Marathi
ms	Malay
mt	Maltese
my	Burmese
na	Nauru
ne	Nepali
nl	Dutch
no	Norwegian
oc	Occitan
om	(Afan) Oromo
or	Oriya
pa	Punjabi
pl	Polish
ps	Pashto, Pushto
pt	Portuguese
qu	Quechua
rm	Rhaeto-Romance

Code	Language
rn	Kirundi
ro	Romanian
ru	Russian
rw	Kinyarwanda
sa	Sanskrit
sd	Sindhi
sg	Sangho
sh	Serbo-Croatian
si	Singhalese
sk	Slovak
sl	Slovenian
sm	Samoan
sn	Shona
so	Somali
sq	Albanian
sr	Serbian
ss	Siswati
st	Sesotho
su	Sundanese
sv	Swedish
sw	Swahili
ta	Tamil
te	Telugu
tg	Tajik
th	Thai
ti	Tigrinya
tk	Turkmen
tl	Tagalog
tn	Setswana
to	Tongan
tr	Turkish
ts	Tsonga
tt	Tatar
tw	Twi
uk	Ukrainian
ur	Urdu
uz	Uzbek
vi	Vietnamese
vo	Volapuk
wo	Wolof
xh	Xhosa
yo	Yoruba
zh	Chinese
zu	Zulu

## Specifications

### ■ Monitor section

#### Picture Size

- DDX9907XR / DMX957XR
  - : 6.75 inches (diagonal) wide
  - : 152.1 mm (W) × 79.5 mm (H)
  - 5-63/64 × 3-1/8 inch
- DDX9707S / DMX907S / DMX9707S
  - : 6.95 inches (diagonal) wide
  - : 156.6 mm (W) × 81.6 mm (H)
  - 6-3/16 × 3-3/16 inch

#### Display System

- DDX9907XR / DMX957XR: AAS LCD panel
- DDX9707S / DMX907S / DMX9707S: TN LCD panel

#### Drive System

- : TFT active matrix system

#### Number of Pixels

- DDX9907XR / DMX957XR
  - : 2,764,800 (1280H x 720V x RGB)
- DDX9707S / DMX907S / DMX9707S
  - : 1,152,000 (800H x 480V x RGB)

#### Effective Pixels

- : 99.99 %

#### Pixel Arrangement

- : RGB striped arrangement

#### Back Lighting

- : LED

### ■ DVD player section (DDX9907XR / DDX9707S)

#### D/A Converter

- : 24 bit/32 bit

#### Audio Decoder

- : Linear PCM / Dolby Audio / MP3 / WMA / AAC / WAV / FLAC / Vorbis

#### Video Decoder

- : MPEG-1 / MPEG-2 / MPEG-4 / WMV / H.264 / MKV

#### Wow & Flutter

- : Below Measurable Limit

#### Frequency Response

- 96 kHz : 20 – 44,000 Hz
- 48 kHz : 20 – 22,000 Hz
- 44.1 kHz : 20 – 20,000 Hz

#### Total Harmonic Distortion

- : 0.010 % (1 kHz)

#### S/N Ratio (dB)

- : 90.5 dB (DVD-Video 96 kHz)

#### Dynamic Range

- : 89 dB (DVD-Video 96 kHz)

#### Disc Format

- : DVD-Video / VIDEO-CD / CD-DA

#### Quantifying Bit Number

- : 16 bit/20 bit/24 bit

### ■ USB interface section

#### USB Standard

- : USB 2.0 High Speed

#### File System

- : FAT16, FAT32, exFAT, NTFS

#### Maximum Power Supply Current

- : DC 5 V  $\pm$  1.5 A × 2

#### D/A Converter

- : 24 bit/32 bit

#### Audio Decoder

- : MP3 / WMA / AAC / WAV / FLAC / Vorbis

#### Video Decoder

- : MPEG-1 / MPEG-2 / MPEG-4 / WMV / H.264 / MKV

#### Frequency Response

##### (DMX957XR / DMX907S / DMX9707S)

- 192 kHz : 20 – 88,000 Hz
- 96 kHz : 20 – 44,000 Hz
- 48 kHz : 20 – 22,000 Hz
- 44.1 kHz : 20 – 20,000 Hz

#### Total Harmonic Distortion

##### (DMX957XR / DMX907S / DMX9707S)

- : 0.010 % (1 kHz)

#### S/N Ratio (dB) (DMX957XR / DMX907S / DMX9707S)

- : 98.5 dB

#### Dynamic Range (DMX957XR / DMX907S / DMX9707S)

- : 89 dB

### ■ Wireless Mirroring Section

#### Mode

- : Sink

#### Copyright protection

- : HDCP2.2

#### Touch Control

- : UIBC

### ■ Wi-Fi section

#### IEEE Standard

- : 802.11 a/b/g/n/ac

#### Frequency Range

- : Dual Band (2.4GHz/5GHz)

#### Channels

- : Auto(1-11ch)/Auto(149,153,157,161ch)

#### Transfer rates (MAX)

- : 11a: 54 Mbps / 11b: 11 Mbps / 11g: 54 Mbps / 11n: 300 Mbps / 11ac: 867 Mbps

**Output Power****2.4 GHz/SISO**

: 11b: 14 dBm  $\pm$  2 dB / 11g: 13 dBm  $\pm$  2 dB /  
11n(20MHz):12 dBm  $\pm$  2 dB

**5 GHz/SISO**

: 11a: 9 dBm  $\pm$  2 dB /

11n (20 MHz)/11ac (20 MHz): 9 dBm  $\pm$  2 dB /  
11n (40 MHz)/11ac (40 MHz): 8 dBm  $\pm$  2 dB /  
11ac (80 MHz): 8 dBm  $\pm$  2 dB

**5 GHz/MIMO**

: 11n (20 MHz)/11ac (20 MHz): 11 dBm  $\pm$  2 dB /  
11n (40 MHz)/11ac (40 MHz): 11 dBm  $\pm$  2 dB /  
11ac (80 MHz): 11 dBm  $\pm$  2 dB

**Bluetooth section****Technology**

: Bluetooth Ver.5.0

**Frequency**

: 2.402 – 2.480 GHz

**Output Power**

: Power Class2

**Maximum Communication range**

: Line of sight approx. 10m (32.8 ft)

**Audio Codec**

: LDAC (DDX9907XR / DMX957XR) / SBC / AAC

**Profile (Multi Profile support)**

- HFP (V1.7) (Hands Free Profile)
- SPP (Serial Port Profile)
- A2DP (Advanced Audio Distribution Profile)
- AVRCP (V1.6) (Audio/Video Remote Control Profile)
- PBAP (Phonebook Access Profile)

**DSP section****Graphics equalizer**

Band: 13 Band

Frequency (BAND1 – 13)

: 62.5/100/160/250/400/630/1k/1.6k/2.5k/4k/6.3k/  
10k/16k Hz

**Gain**

: -9/-8/-7/-6/-5/-4/-3/-2/-1/0/1/2/3/4/5/6/7/8/9 dB

**2-way X'Over****High pass filter**

Frequency: Through, 30/40/50/60/70/80/90/100/  
120/150/180/220/250 Hz

Slope: -6/-12/-18/-24 dB/Oct.

**Low pass filter**

Frequency: 30/40/50/60/70/80/90/100/120/150/  
180/220/250 Hz, Through

Slope: -6/-12/-18/-24 dB/Oct.

**3-way X'Over (DDX9907XR / DMX957XR / DMX907S)****High pass filter**

Frequency: 250/300/1k/1.6k/2.5k/4k/5k/6.3k/8k/  
10k/12.5k Hz

Slope: -12/-18/-24 dB/Oct.

**Band pass filter**

Frequency: Through, 50/60/70/80/90/100/120/150/  
180/220/250/300 Hz  
250/300/1k/1.6k/2.5k/4k/5k/6.3k/8k Hz,  
Through

Slope: -12/-18/-24 dB/Oct.

**Low pass filter**

Frequency: 30/40/50/60/70/80/90/100/120/150 Hz,  
Through

Slope: -12/-18/-24 dB/Oct.

**Position****Front/Rear/Subwoofer Delay**

: 0 – 20.01 ft (0.03 or 0.04 ft Step)

**Gain**

: -8 – 0 dB

**Subwoofer level**

: -50 – +10 dB

**Digital FM tuner section**

(DDX9907XR / DMX957XR / DMX907S)

**Frequency Range (step)**

: 87.9 MHz – 107.9 MHz (200 kHz)

**Frequency Response ( $\pm$  3.0 dB)**

: 20 Hz – 20 kHz

**S/N Ratio**

: 80 dB (STEREO)

**Digital AM tuner section**

(DDX9907XR / DMX957XR / DMX907S)

**Frequency Range (step)**

: 530 kHz – 1700 kHz (10 kHz)

**Frequency Response ( $\pm$  3.0 dB)**

: 40 Hz – 15 kHz

**S/N Ratio (dB)**

: 80 dB (STEREO)

**FM tuner section****Frequency Range (step)**

: 87.9 MHz – 107.9 MHz (200 kHz)

**Usable Sensitivity (S/N : 30 dB)**

: 9.3 dBf (0.8  $\mu$ V/ 75  $\Omega$ )

**Quieting Sensitivity (S/N : 46 dB)**

: 10.2 dBf (1.13  $\mu$ V/ 75  $\Omega$ )

**Frequency Response**

: 30 Hz – 15 kHz

**S/N Ratio (dB)**

: 65 dB (MONO)

**Selectivity ( $\pm$  400 kHz)**

: Over 80 dB

## Appendix

### Stereo Separation

: 45 dB (1 kHz)

### ■ AM tuner section

#### Frequency Range (step)

: 530 kHz – 1700 kHz (10 kHz)

#### Usable Sensitivity

: 28 dB $\mu$

### ■ Video section

#### Color System of External Video Input

: NTSC/PAL

#### External Video Input Level (mini jack)

: 1 Vp-p/75  $\Omega$

#### External Audio Max Input Level (mini jack)

: 2 V/25 k $\Omega$

#### Video Input Level (RCA jacks)

: 1 Vp-p/75  $\Omega$

#### Video Output Level (RCA jacks)

: 1 Vp-p/75  $\Omega$

#### Audio Output Level (mini jack)

: 0.9 V/10 k $\Omega$

### ■ Audio section

#### Maximum Power (Front & Rear)

: 50 W  $\times$  4

#### Typical Power Output (Front & Rear)

Full Bandwidth Power (at less than 1% THD)

: 22 W  $\times$  4

#### Output frequency band

: 20 – 88,000 Hz

#### Preout Level (V)

DDX9907XR / DMX957XR / DMX907S

: 5 V/10 k $\Omega$

DDX9707S / DMX9707S

: 4 V/10 k $\Omega$

#### Input Impedance

:  $\leq$  300  $\Omega$

#### Speaker Impedance

: 4 – 8  $\Omega$

### ■ General

#### Operating Voltage

: 12V DC car battery

#### Installation Dimensions (W $\times$ H $\times$ D)

DDX9907XR / DDX9707S / DMX957XR

: 178  $\times$  100  $\times$  160 mm

7  $\times$  3-15/16  $\times$  6-5/16 inch

DMX907S / DMX9707S

: 178  $\times$  100  $\times$  155 mm

7  $\times$  3-15/16  $\times$  6-1/8 inch

#### With Sleeve

DDX9907XR / DDX9707S / DMX957XR

: 182  $\times$  112  $\times$  163 mm

7-3/16  $\times$  4-7/16  $\times$  6-7/16 inch

DMX907S / DMX9707S

: 182  $\times$  112  $\times$  153 mm

7-3/16  $\times$  4-7/16  $\times$  6 inch

#### Weight

DDX9907XR / DDX9707S

: 2.4 kg (5.3 lbs)

DMX957XR

: 1.9 kg (4.2 lbs)

DMX907S / DMX9707S

: 1.7 kg (3.8 lbs)

### NOTE

- Although the effective pixels for the liquid crystal panel is given as 99.99% or more, 0.01% of pixels may not light or may light incorrectly.

**Specifications are subject to change without prior notice.**

## About this Unit

### ■ Copyrights

- The Bluetooth® word mark and logos are registered trademarks owned by Bluetooth SIG, Inc. and any use of such marks by JVCKENWOOD Corporation is under license. Other trademarks and trade names are those of their respective owners.
- LDAC and LDAC logo are trademarks of Sony Corporation.
- Hi-Res Audio logo and Hi-Res Audio Wireless logo are used under license from Japan Audio Society.



- Manufactured under license from Dolby Laboratories. Dolby, Dolby Audio and the double-D symbol are trademarks of Dolby Laboratories.
-  is a trademark of DVD Format/Logo Licensing Corporation registered in the U.S., Japan and other countries.
- This item incorporates copy protection technology that is protected by U.S. patents and other intellectual property rights of Rovi Corporation. Reverse engineering and disassembly are prohibited.
- Windows Media is a registered trademark or trademark of Microsoft Corporation in the United States and/or other countries. This product is protected by certain intellectual property rights of Microsoft. Use or distribution of such technology outside of this product is prohibited without a license from Microsoft.
- This software is based in part on the work of the independent JPEG Group.
- Use of the Made for Apple badge means that an accessory has been designed to connect specifically to the Apple product(s) identified in the badge, and has been certified by the developer to meet Apple performance standards. Apple is not responsible for the operation of this device or its compliance with safety and regulatory standards. Please note that the use of this accessory with an Apple product may affect wireless performance.
- Apple, iPhone, iPod, iPod touch, and Lightning are trademarks of Apple Inc., registered in the U.S. and other countries.
- Apple, Siri, Apple CarPlay, Apple Music and Apple CarPlay logo are trademarks of Apple Inc., registered in the U.S. and other countries.
- IOS is a trademark or registered trademark of Cisco in the U.S. and other countries and is used under license.
- Sirius, XM and all related marks and logos are trademarks of Sirius XM Radio Inc. All rights reserved.
- HD Radio Technology manufactured under license from iBiquity Digital Corporation. U.S. and Foreign Patents. For patents see <https://dts.com/patents>.

HD Radio and the HD, HD Radio, and "ARC" logos are registered trademarks or trademarks of iBiquity Digital Corporation in the United States and/or other countries.

- Google, Android, Google Play and Android Auto are trademarks of Google LLC.
- To use Android Auto on your car display, you'll need an Android Auto compatible vehicle or aftermarket stereo, an Android phone running Android 5.0 or higher, and the Android Auto app.
- Wi-Fi® is a registered trademark of Wi-Fi Alliance®.
- The Wi-Fi CERTIFIED™ Logo is a certification mark of Wi-Fi Alliance®.
- Copyright© 2018 Techpoint, Inc. All rights reserved.

### HD-TVI™

- Linux® is the registered trademark of Linus Torvalds in the U.S. and other countries.
- This product includes FontAvenue® fonts licensed by NEC Corporation. FontAvenue is a registered trademark of NEC Corporation.

### FontAvenue

- This product includes "Ubiquitous QuickBoot™" technology developed by Ubiquitous Corp. Ubiquitous QuickBoot™ is a trademark of Ubiquitous Corp. Copyright© 2017 Ubiquitous Corp. All rights reserved.



- THIS PRODUCT IS LICENSED UNDER THE AVC PATENT PORTFOLIO LICENSE FOR THE PERSONAL USE OF A CONSUMER OR OTHER USES IN WHICH IT DOES NOT RECEIVE REMUNERATION TO (i) ENCODE VIDEO IN COMPLIANCE WITH THE AVC STANDARD ("AVC VIDEO") AND/OR (ii) DECODE AVC VIDEO THAT WAS ENCODED BY A CONSUMER ENGAGED IN A PERSONAL ACTIVITY AND/OR WAS OBTAINED FROM A VIDEO PROVIDER LICENSED TO PROVIDE AVC VIDEO. NO LICENSE IS GRANTED OR SHALL BE IMPLIED FOR ANY OTHER USE. ADDITIONAL INFORMATION MAY BE OBTAINED FROM MPEG LA, L.L.C. SEE [HTTPS://WWW.MPEGLA.COM](https://www.mpegla.com)
- THIS PRODUCT IS LICENSED UNDER THE MPEG-4 VISUAL PATENT PORTFOLIO LICENSE FOR THE PERSONAL AND NON-COMMERCIAL USE OF A CONSUMER FOR (i) ENCODING VIDEO IN COMPLIANCE WITH THE MPEG-4 VISUAL STANDARD ("MPEG-4 VIDEO") AND/OR (ii) DECODING MPEG-4 VIDEO THAT WAS ENCODED BY A CONSUMER ENGAGED IN A PERSONAL AND NON-COMMERCIAL ACTIVITY AND/OR WAS OBTAINED FROM A VIDEO PROVIDER LICENSED BY MPEG LA TO PROVIDE MPEG-4 VIDEO. NO LICENSE IS GRANTED OR SHALL BE IMPLIED FOR ANY OTHER USE. ADDITIONAL INFORMATION INCLUDING THAT RELATING TO PROMOTIONAL, INTERNAL AND COMMERCIAL USES AND LICENSING MAY BE OBTAINED FROM MPEG LA, L.L.C. SEE [HTTPS://WWW.MPEGLA.COM](https://www.mpegla.com).

## Appendix

- THIS PRODUCT IS LICENSED UNDER THE VC-1 PATENT PORTFOLIO LICENSE FOR THE PERSONAL AND NON-COMMERCIAL USE OF A CONSUMER TO ( i ) ENCODE VIDEO IN COMPLIANCE WITH THE VC-1 STANDARD ("VC-1 VIDEO") AND/OR ( ii ) DECODE VC-1 VIDEO THAT WAS ENCODED BY A CONSUMER ENGAGED IN A PERSONAL AND NON-COMMERCIAL ACTIVITY AND/OR WAS OBTAINED FROM A VIDEO PROVIDER LICENSED TO PROVIDE VC-1 VIDEO. NO LICENSE IS GRANTED OR SHALL BE IMPLIED FOR ANY OTHER USE. ADDITIONAL INFORMATION MAY BE OBTAINED FROM MPEG LA, L.L.C. SEE [HTTPS://WWW.MPEGLA.COM](https://www.mpegla.com)

- libFLAC

Copyright (C) 2000-2009 Josh Coalson  
Copyright (C) 2011-2013 Xiph.Org Foundation  
Redistribution and use in source and binary forms, with or without modification, are permitted provided that the following conditions are met:

- Redistributions of source code must retain the above copyright notice, this list of conditions and the following disclaimer.
- Redistributions in binary form must reproduce the above copyright notice, this list of conditions and the following disclaimer in the documentation and/or other materials provided with the distribution.

– Neither the name of the Xiph.org Foundation nor the names of its contributors may be used to endorse or promote products derived from this software without specific prior written permission. THIS SOFTWARE IS PROVIDED BY THE COPYRIGHT HOLDERS AND CONTRIBUTORS "AS IS" AND ANY EXPRESS OR IMPLIED WARRANTIES, INCLUDING, BUT NOT LIMITED TO, THE IMPLIED WARRANTIES OF MERCHANTABILITY AND FITNESS FOR A PARTICULAR PURPOSE ARE DISCLAIMED. IN NO EVENT SHALL THE FOUNDATION OR CONTRIBUTORS BE LIABLE FOR ANY DIRECT, INDIRECT, INCIDENTAL, SPECIAL, EXEMPLARY, OR CONSEQUENTIAL DAMAGES (INCLUDING, BUT NOT LIMITED TO, PROCUREMENT OF SUBSTITUTE GOODS OR SERVICES; LOSS OF USE, DATA, OR PROFITS; OR BUSINESS INTERRUPTION) HOWEVER CAUSED AND ON ANY THEORY OF LIABILITY, WHETHER IN CONTRACT, STRICT LIABILITY, OR TORT (INCLUDING NEGLIGENCE OR OTHERWISE) ARISING IN ANY WAY OUT OF THE USE OF THIS SOFTWARE, EVEN IF ADVISED OF THE POSSIBILITY OF SUCH DAMAGE.

- libvorbis

Copyright (c) 2002-2008 Xiph.org Foundation  
Redistribution and use in source and binary forms, with or without modification, are permitted provided that the following conditions are met:

- Redistributions of source code must retain the above copyright notice, this list of conditions and the following disclaimer.
- Redistributions in binary form must reproduce the above copyright notice, this list of conditions and the following disclaimer in the documentation and/or other materials provided with the distribution.

- Neither the name of the Xiph.org Foundation nor the names of its contributors may be used to endorse or promote products derived from this software without specific prior written permission.

THIS SOFTWARE IS PROVIDED BY THE COPYRIGHT HOLDERS AND CONTRIBUTORS "AS IS" AND ANY EXPRESS OR IMPLIED WARRANTIES, INCLUDING, BUT NOT LIMITED TO, THE IMPLIED WARRANTIES OF MERCHANTABILITY AND FITNESS FOR A PARTICULAR PURPOSE ARE DISCLAIMED. IN NO EVENT SHALL THE FOUNDATION OR CONTRIBUTORS BE LIABLE FOR ANY DIRECT, INDIRECT, INCIDENTAL, SPECIAL, EXEMPLARY, OR CONSEQUENTIAL DAMAGES (INCLUDING, BUT NOT LIMITED TO, PROCUREMENT OF SUBSTITUTE GOODS OR SERVICES; LOSS OF USE, DATA, OR PROFITS; OR BUSINESS INTERRUPTION) HOWEVER CAUSED AND ON ANY THEORY OF LIABILITY, WHETHER IN CONTRACT, STRICT LIABILITY, OR TORT (INCLUDING NEGLIGENCE OR OTHERWISE) ARISING IN ANY WAY OUT OF THE USE OF THIS SOFTWARE, EVEN IF ADVISED OF THE POSSIBILITY OF SUCH DAMAGE.

- libogg

Copyright (c) 2002, Xiph.org Foundation  
Redistribution and use in source and binary forms, with or without modification, are permitted provided that the following conditions are met:

- Redistributions of source code must retain the above copyright notice, this list of conditions and the following disclaimer.
- Redistributions in binary form must reproduce the above copyright notice, this list of conditions and the following disclaimer in the documentation and/or other materials provided with the distribution.

– Neither the name of the Xiph.org Foundation nor the names of its contributors may be used to endorse or promote products derived from this software without specific prior written permission.

THIS SOFTWARE IS PROVIDED BY THE COPYRIGHT HOLDERS AND CONTRIBUTORS "AS IS" AND ANY EXPRESS OR IMPLIED WARRANTIES, INCLUDING, BUT NOT LIMITED TO, THE IMPLIED WARRANTIES OF MERCHANTABILITY AND FITNESS FOR A PARTICULAR PURPOSE ARE DISCLAIMED. IN NO EVENT SHALL THE FOUNDATION OR CONTRIBUTORS BE LIABLE FOR ANY DIRECT, INDIRECT, INCIDENTAL, SPECIAL, EXEMPLARY, OR CONSEQUENTIAL DAMAGES (INCLUDING, BUT NOT LIMITED TO, PROCUREMENT OF SUBSTITUTE GOODS OR SERVICES; LOSS OF USE, DATA, OR PROFITS; OR BUSINESS INTERRUPTION) HOWEVER CAUSED AND ON ANY THEORY OF LIABILITY, WHETHER IN CONTRACT, STRICT LIABILITY, OR TORT (INCLUDING NEGLIGENCE OR OTHERWISE) ARISING IN ANY WAY OUT OF THE USE OF THIS SOFTWARE, EVEN IF ADVISED OF THE POSSIBILITY OF SUCH DAMAGE.



**■ FCC CAUTION**

Changes or modifications not expressly approved by the party responsible for compliance could void the user's authority to operate the equipment.

**NOTE**

- This equipment has been tested and found to comply with the limits for a Class B digital device, pursuant to part 15 of the FCC Rules. These limits are designed to provide reasonable protection against harmful interference in a residential installation.
- This equipment generates, uses and can radiate radio frequency energy and, if not installed and used in accordance with the instructions, may cause harmful interference to radio communications. However, there is no guarantee that interference will not occur in a particular installation. If this equipment does cause harmful interference to radio or television reception, which can be determined by turning the equipment off and on, the user is encouraged to try to correct the interference by one or more of the following measures:
  - Reorient or relocate the receiving antenna.
  - Increase the separation between the equipment and receiver.
  - Connect the equipment into an outlet on a circuit different from that to which the receiver is connected.
  - Consult the dealer or an experienced radio/TV technician for help.

**▲ CAUTION**

Use of controls or adjustments or performance of procedures other than those specified herein may result in hazardous radiation exposure.

In compliance with Federal Regulations, following are reproductions of labels on, or inside the product relating to laser product safety.

JVCKENWOOD Corporation  
2967-3, ISHIKAWA-MACHI,  
HACHIOJI-SHI, TOKYO, JAPAN

THIS PRODUCT COMPLIES WITH DHHS RULES  
21 CFR SUBCHAPTER J IN EFFECT AT DATE OF  
MANUFACTURE.

Location: Bottom plate (DDX9907XR)  
Top plate (DDX9707S)

This transmitter must not be co-located or operated in conjunction with any other antenna or transmitter.

**■ ISED CAUTION**

This device contains licence-exempt transmitter(s)/ receiver(s) that comply with Innovation, Science and Economic Development Canada's licence-exempt RSS(s).

Operation is subject to the following two conditions:

- (1) This device may not cause interference.
- (2) This device must accept any interference, including interference that may cause undesired operation of the device.

**▲ CAUTION**

This equipment complies with FCC/ISED radiation exposure limits set forth for an uncontrolled environment and meets the FCC radio frequency (RF) Exposure Guidelines and RSS-102 of the ISED radio frequency (RF) Exposure rules. This equipment should be installed and operated keeping the radiator at least 20cm or more away from person's body.

**Supplier's Declaration of Conformity**

Trade Name: KENWOOD  
Products: MONITOR WITH DVD RECEIVER  
Model Name: DDX9907XR / DDX9707S  
Products: MONITOR WITH RECEIVER  
Model Name: DMX957XR / DMX907S /  
DMX9707S  
Responsible Party: JVCKENWOOD USA  
CORPORATION  
2201 East Dominguez Street,  
Long Beach, CA 90810, U.S.A.  
PHONE: 310 639-9000

THIS DEVICE COMPLIES WITH PART 15 OF THE FCC  
RULES. OPERATION IS SUBJECT TO THE FOLLOWING  
TWO CONDITIONS:

- (1) THIS DEVICE MAY NOT CAUSE HARMFUL  
INTERFERENCE, AND
- (2) THIS DEVICE MUST ACCEPT ANY INTERFERENCE  
RECEIVED, INCLUDING INTERFERENCE THAT MAY  
CAUSE UNDESIRED OPERATION.

**■ Información acerca de la eliminación de equipos eléctricos y electrónicos al final de la vida útil (aplicable a los países que hayan adoptado sistemas independientes de recogida de residuos)**



Los productos con el símbolo de un contenedor con ruedas tachado no podrán ser desechados como residuos domésticos.

Los equipos eléctricos y electrónicos al final de la vida útil, deberán ser reciclados en instalaciones que puedan dar el tratamiento adecuado a estos productos y a sus subproductos residuales correspondientes. Póngase en contacto con su administración local para obtener información sobre el punto de recogida más cercano. Un tratamiento correcto del reciclaje y la eliminación de residuos ayuda a conservar los recursos y evita al mismo tiempo efectos perjudiciales en la salud y el medio ambiente.

**■ Informação sobre a eliminação de pilhas**

Este produto não deve ser eliminado como lixo doméstico geral. Devolva a pilha usada ao revendedor ou entidade autorizada para que a mesma seja devolvida ao fabricante ou importador.

A reciclagem e a eliminação de lixo de maneira apropriada ajudarão a conservar os recursos naturais ao mesmo tempo que prevenirão os efeitos prejudiciais à nossa saúde e ao meio ambiente.

**■ Para cumplimiento de la IFT:**

“La operación de este equipo esta sujeta a las siguientes dos condiciones:

(1) es posible que este equipo o dispositivo no cause interferencia perjudicial y

(2) este equipo o dispositivo debe aceptar cualquier interferencia,

incluyendo la que pueda causar su operación no deseada.”



android  
auto



Hi-Res Audio logo and Hi-Res Audio Wireless logo are used under license from Japan Audio Society.



**HD Radio®**  
This HD Radio receiver enables:

- HD2/HD3
- Bookmark
- Digital Sound
- Program Info
- Artist Experience
- Emergency Alerts

---

# KENWOOD